



## MANUALE DI INSTALLAZIONE, USO E MANUTENZIONE

SISTEMA MONOBLOCCO  
POMPA DI CALORE CON  
GRUPPO IDRONICO

FRYO-9PI  
FRYO-13PI



# Catalogue

<b>1. Before use</b> .....	<b>1</b>
1.1 Safety precautions .....	1
1.2 Working principle .....	3
1.3 Main components .....	4
1.4 Specifications .....	6
<b>2. Installation</b> .....	<b>7</b>
2.1 General application system introduction .....	7
2.2 Installation of the Monoblock unit .....	9
2.3 Accessories .....	11
2.4 Wiring .....	12
2.5 Water Pipe Connection .....	15
2.6 Test Run .....	16
<b>3. Usage</b> .....	<b>17</b>
3.1 Introduction of operation panel .....	17
3.2 Parameter Setting Overview .....	19
3.3 Basic Setting .....	24
3.4 Failure .....	36
3.5 Error Codes .....	47
<b>4. Maintenance</b> .....	<b>57</b>
4.1 Attention .....	57
4.2 Cleaning of water filter .....	57
4.3 Cleaning of plate heat exchanger .....	57
4.4 Condenser coil .....	58
4.5 Service of monoblock unit .....	59
4.6 Trouble-shooting .....	60
<b>5. Attached drawing</b> .....	<b>66</b>
5.1 Outlines and dimensions .....	66
5.2 Exploded view .....	68
5.3 Wiring diagram .....	70

# 1. Before use

## 1.1 Safety precautions

The following symbols are very important. Please be sure to understand their meaning, which concerns the product and your personal safety.



Warning



Caution



Prohibition



The installation, dismantlement and maintenance of the unit must be performed by qualified personnel. It is forbidden to do any changes to the structure of the unit. Otherwise injury of person or unit damage might happen.

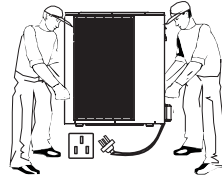

To avoid electrical shock, make sure to disconnect the power supply 1 minute or more before servicing the electrical parts. Even after 1 minute, always measure the voltage at the terminals of main circuit capacitors or electrical parts and, before touching, make sure that those voltages are lower than the safety voltage.



Be sure to read this manual before use.

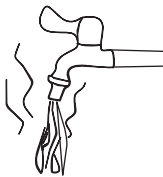

For sanitary hot water, please always add a mixture valve before water tap and set it to proper temperature.

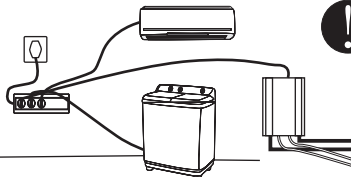

Use a dedicated socket for this unit, otherwise malfunction may occur.

Ground wire

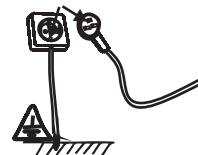

The power supply to the unit must be grounded.



This appliance can be used by children aged from 8 years and above and persons with reduced physical, sensory or mental capabilities or lack of experience and knowledge if they have been given supervision or instruction concerning use of the appliance in a safe way and understand the hazards involved. Children shall not play with the appliance. Cleaning and user maintenance shall not be made by children without supervision.

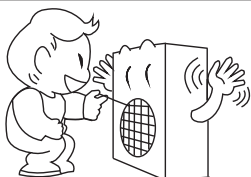

Do not touch the air outlet grill when fan motor is running.



Do not touch the power plug with wet hands. Never pull out the plug by pulling the power cable.

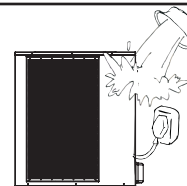

Water or any kind of liquid is strictly forbidden to be poured into the product, or may cause electric creepage or breakdown of the product.

# 1. Before use

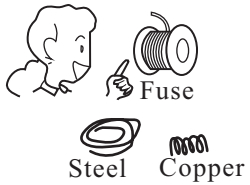
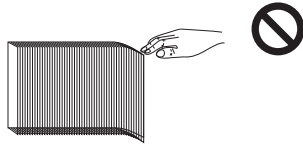
 <p>When the power cord gets loose or damaged, always get a qualified person to fix it.</p>	 <p>Please select the correct fuse or breaker as per recommended. Steel wire or copper wire cannot be taken as substitute for fuse or breaker. Otherwise, damages maybe caused.</p>	 <p>Be aware fingers might be hurt by the fin of the coil.</p>
--	--	---

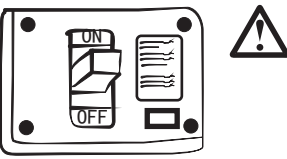
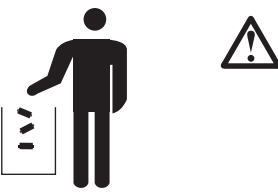
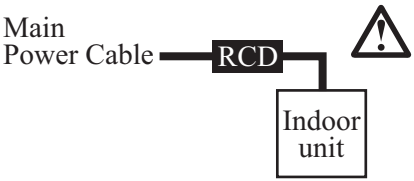
 <p>It is mandatory to use a suitable circuit breaker for the heat pump and make sure the power supply to the unit corresponds to the specifications. Otherwise the unit might be damaged.</p>	 <p>Disposal of Scrap Batteries (if there is) . Please discard the batteries as sorted municipal waste at the accessible collection point.</p>	 <p>Installation of a residual current device (RCD) having a rated residual operating current not exceeding 30 mA is advisable.</p>
---	--	--

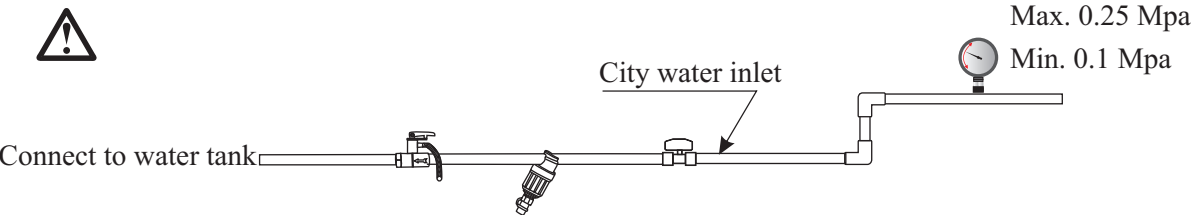
 <p>Connect to water tank</p> <p>City water inlet</p> <p>Max. 0.25 Mpa Min. 0.1 Mpa</p> <p>The maximum inlet water pressure, in pascals: 0.25Mpa. The minimum inlet water pressure, in pascals, if this is necessary for the correct operation of the appliance: 0.1Mpa.</p>
--

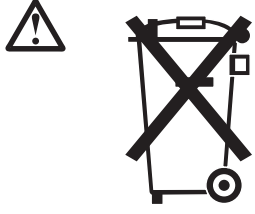
	<p>This marking indicates that this product should not be disposed with other household wastes throughout the EU. To prevent possible harm to the environment or human health from uncontrolled waste disposal, recycle it responsibly to promote the sustainable reuse of material resources. To return your used device, please use the return and collection systems or contact the retailer where the product was purchased. They can take this product for environmental safe recycling.</p>
---	---

# 1. Before use

## 1.2 Working principle

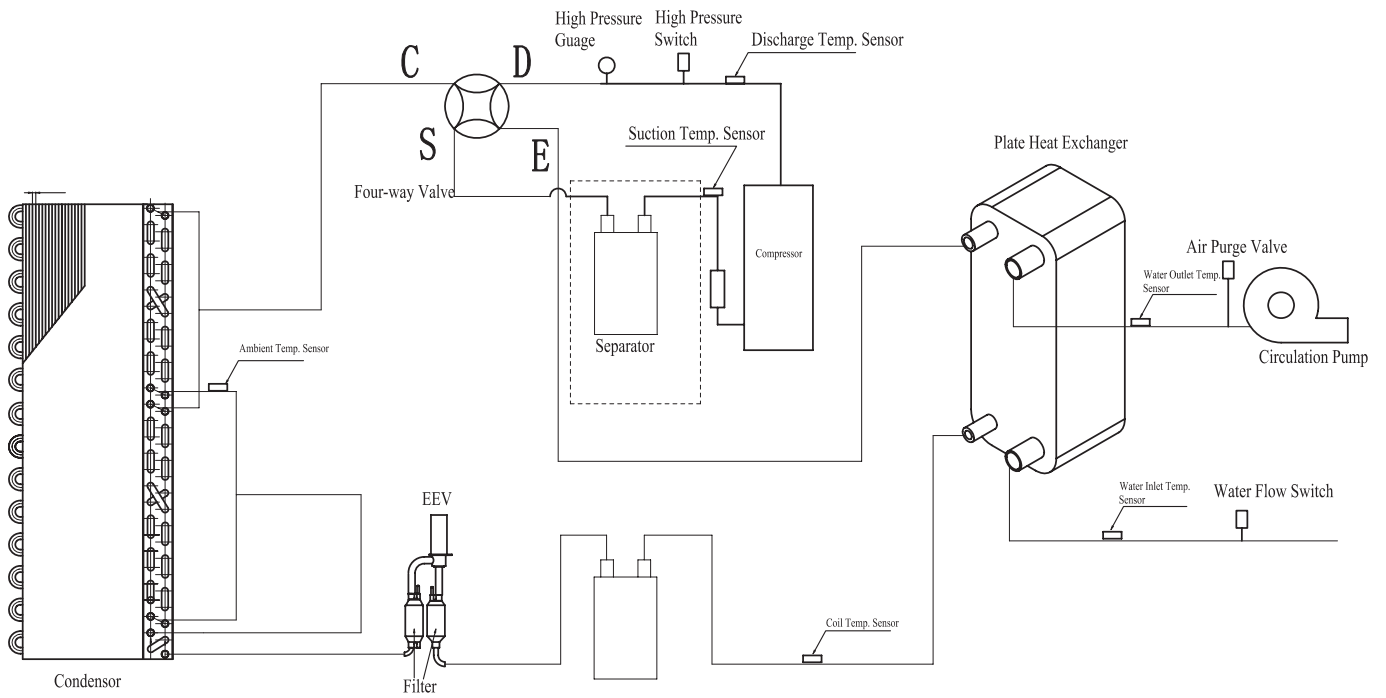

# 1. Before use

## 1.3 Main components

### 1.3.1 FRYO-9PI

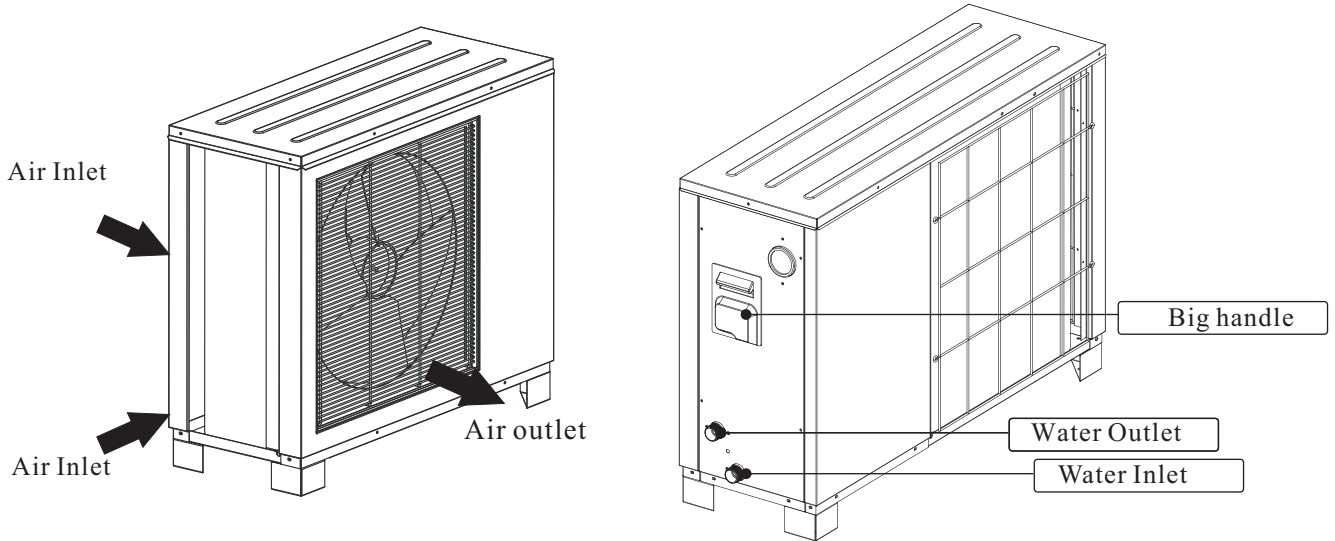

### 1.3.2 FRYO-13PI

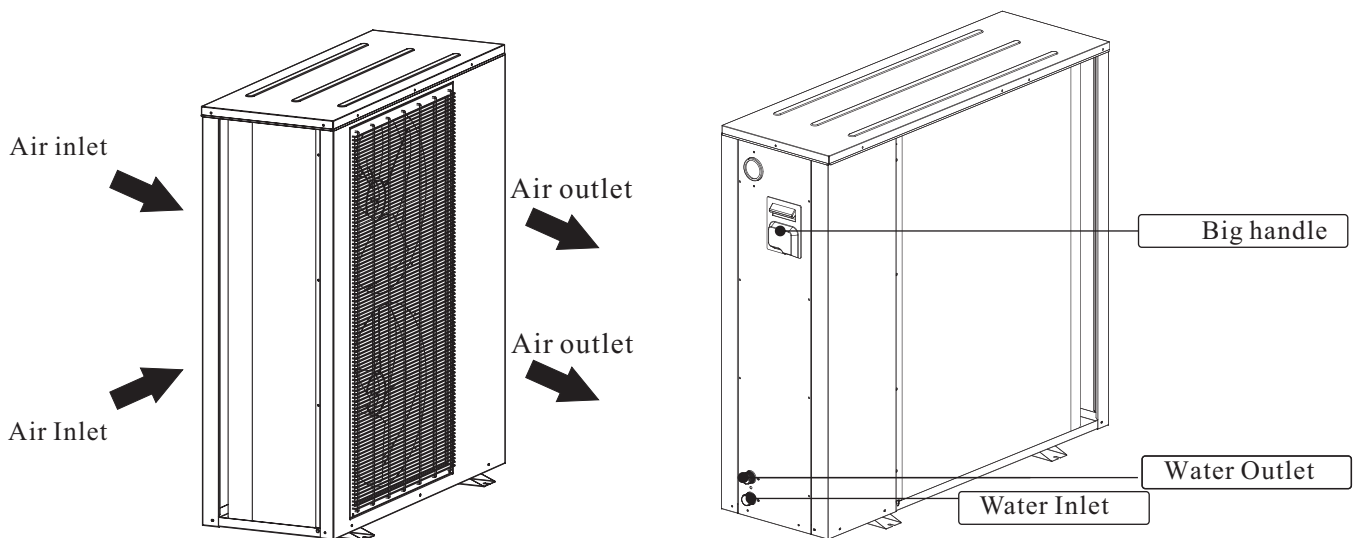

# 1. Before use

## 1.4 Specifications

Type of Product	DC Inverter Air to Water Heat Pump Unit			
Model		FRYO-9PI	FRYO-13PI	
Power Supply	V/Hz/Ph	220-240/50/1		
Refrigerant	Kg	R410A/2.45	R410A/3.0	
Max. Heating Capacity (1)	KW	10.10	12.6	
C.O.P (1)	W/W	4.03	3.89	
Heating Capacity Min./Max.(1)	KW	4.33/10.10	4.2/12.6	
Heating Power Input Min./Max.(1)	W	975/2153	926/3072	
C.O.P Min./Max.(1)	W/W	4.02/4.65	3.89/4.77	
Max. Heating Capacity(2)	KW	9.53	11.5	
C.O.P (2)	W/W	3.17	3.08	
Heating Capacity Min./Max.(2)	KW	4.19/9.53	3.76/11.5	
Heating power input Min./Max.(2)	W	1230/2990	1267/3723	
C.O.P Min./Max.(2)	W/W	3.12/3.55	2.97/3.28	
Max. Cooling Capacity(3)	KW	6.84	10.3	
E.E.R (3)	W/W	2.09	3.29	
Cooling Capacity Min./Max.(3)	KW	4.10/6.84	4.29/10.37	
Cooling Power Input Min./Max.(3)	W	1230/3280	957/3156	
E.E.R Min./Max.(3)	W/W	2.09/3.32	3.29/4.63	
Max. Cooling Capacity(4)	KW	5.05	7.9	
E.E.R(4)	W/W	1.58	2.63	
Cooling Capacity Min./Max.(4)	KW	2.34/5.05	2.34/7.91	
Cooling Power Input Min./Max.(4)	W	1080/3200	1000/3012	
E.E.R Min./Max.(4)	W/W	1.58/2.40	2.33/3.12	
Circuit Max. Pressure	bar	42		
Rated Power Water Pump	W	87		
Compressor	Type	Twin Rotary		
	Quantity/System	1		
	Oil	FV50S		
Fan	Quantity	1	2	
	Airflow	m <sup>3</sup> /h	3000	4100
	Rated Power	W	60	120
Allowable Fan Flow	Face Area	m <sup>2</sup>	0.542	1.5
	Row-Fins/Inch	2 Rows-14		
	Tube.Dia	Inch	3/8 O.D	
Noise Level	Outdoor	dB (A)	56	59



# 1. Before use

Type Of Product		DC Inverter Air To Water Heat Pump Unit		
Model			FRYO-9PI	FRYO-13PI
Water Side Heat Exchanger	Type		Scambiatore a piastre	
	Material		Acciaio - Rame	
	Water Pressure Drop	Kpa	23	26
	Pipe Connection	Inch	G1"	
Allowable Water Flow	Min. Water Flow		0.26	0.37
	Rated Water Flow	L/S	0.43	0.61
	Max Water Flow		0.51	0.73
Net Dimension (L×D×H)	Monoblock Unit	mm	934×354×753	1123×400×1195
Package Dimension (L×D×H)	Mnoblock Unit	mm	990×440×810	1330×490×1330
Operation Ambient Temp. Range	Heating	°C	-25~46	
	Cooling	°C	0~55	
Operation Inlet Water Temp. Range		°C	7~75	
Water Volumn		Kg	4.5	

## NOTE:

- (1) Heating condition: water in/out temperature:30°C/35°C, ambient temperature:DB/WB 7/6°C;
- (2) Heating condition: water in/out temperature:40°C/45°C, ambient temperature:DB/WB 7/6°C;
- (3) Cooling condition: water in/out temperature:23°C/18°C, ambient temperature:35°C;
- (4) Cooling condition: water in/out temperature:12°C/7°C, ambient temperature:35°C.
- (5) The specifications are subject to change without prior notice.

For actual specifications of the unit, please refer to the specification stickers on the unit.

# 2. Installation

## 2.1 Application system introduction

Application 1: Sanitary hot water

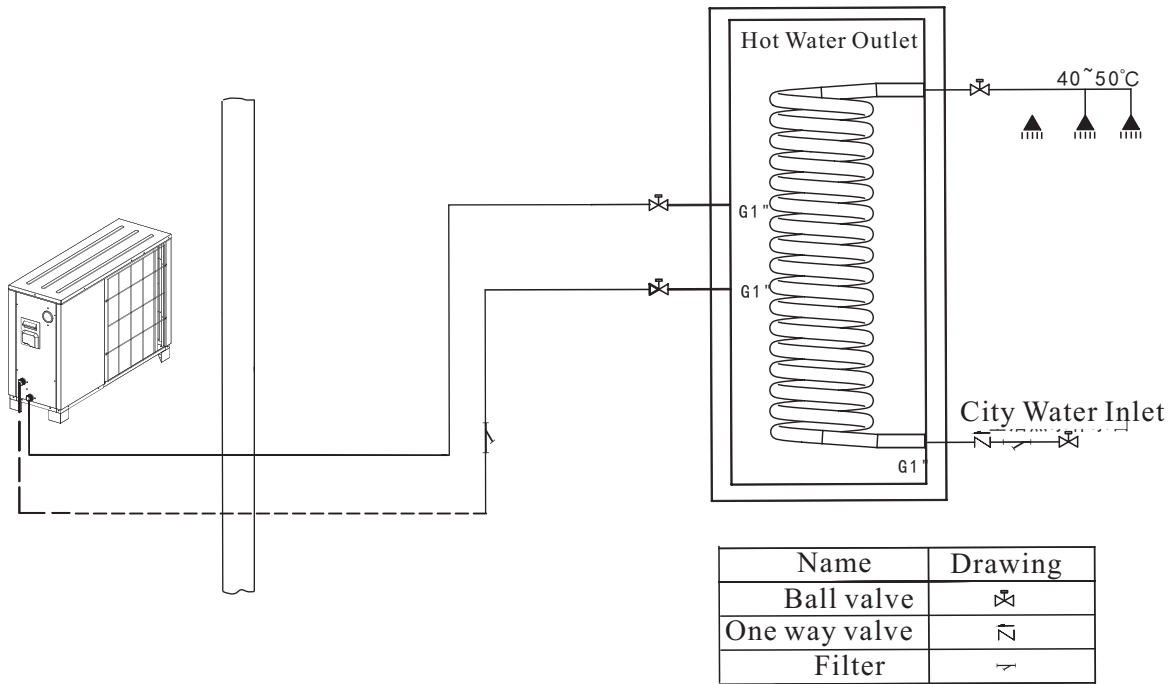

Application 2: Floor heating system

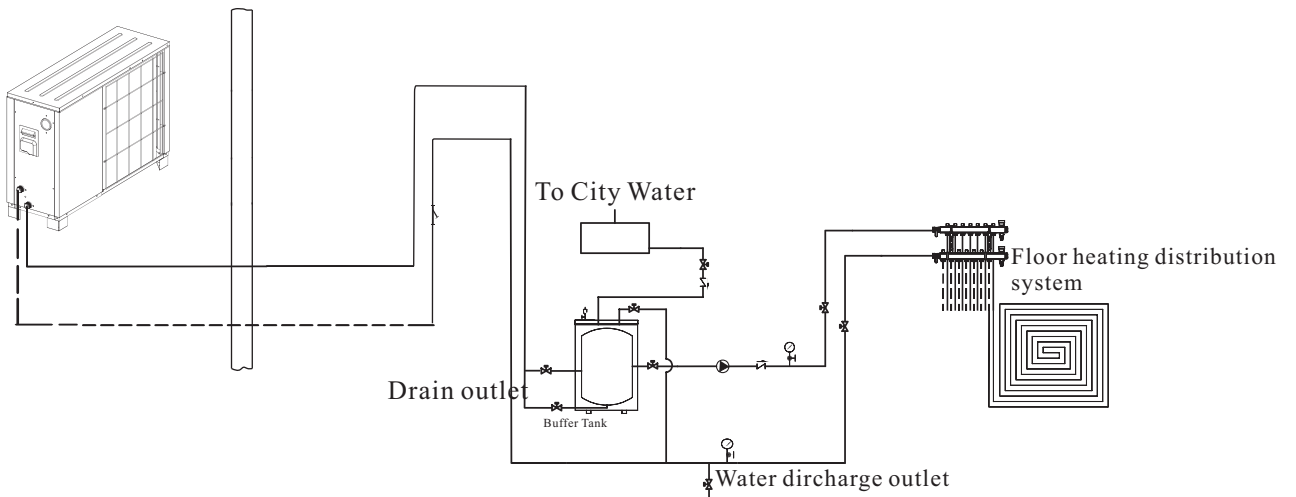

Name	Drawing
Ball valve	
One way valve	
Filter	
Safe valve	
Air discharge valve	
Water pressure gauge	
Motor three way valve	

## 2. Installation

### Application 3: Heating and cooling system

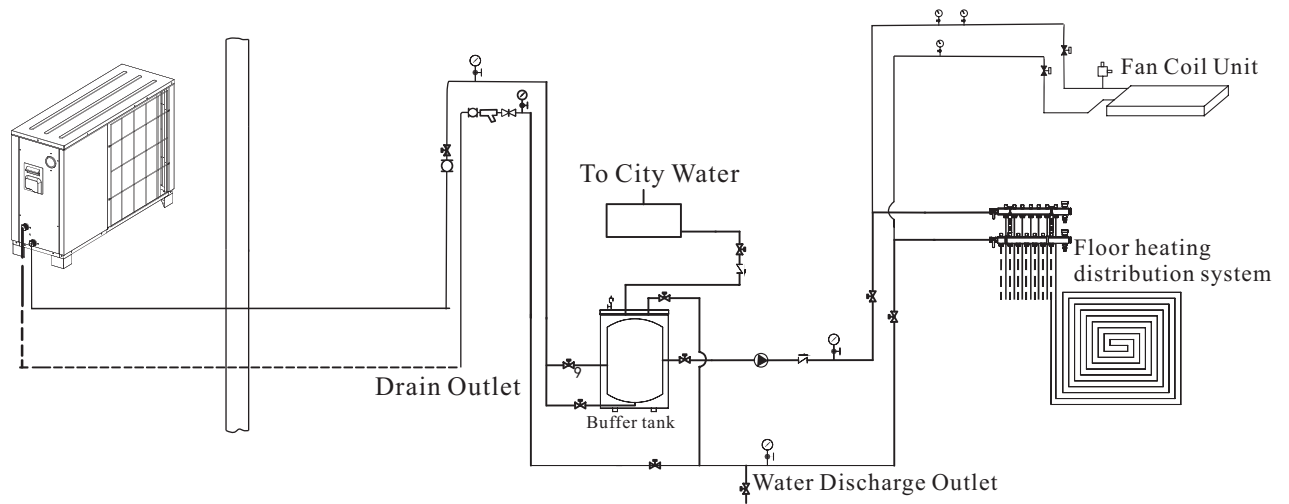

Name	Drawing
Ball valve	
One way valve	
Filter	
Safe valve	
Air discharge valve	
Water pressure gauge	
Motor three way valve	

## 2. Installation

### 2.2 Installation of the monoblock unit

#### 2.2.1 Installation notes

- 1) The monoblock unit can be located in a open space, corridor, balcony, and roof.
- 2) The monoblock unit shall be placed in dry and well-ventilated environment; If the monoblock unit is installed in humid environment, electronic components may get corroded, or short-circuited because of heavy humidity.
- 3) Monoblock unit mustn't be installed in an environment where volatile, corrosive or flammable liquid or gas exists.
- 4) Please don't install monoblock unit close to bedroom or living room, because there is some noise when it's running.
- 5) When installing the unit in harsh climatic conditions, sub-zero temperatures, snow, humidity..., please raise the unit above the ground by about 50cm.  
It's recommended to install an awning above the monoblock unit, to protect the snow from clogging in the air inlet and outlet and ensure the normal running.
- 6) Please ensure there is drainage system around the location, to drain the condensate water under defrosting mode.
- 7) When installing the unit, tilt it by 1cm/m for rain water evacuation.
- 8) Install monoblock unit far away from the exhaust port of kitchen, to avoid oil smoke entering into monoblock unit and adhering to heat exchanger. It's hard to clean up.
- 9) Please don't install the indoor control unit and monoblock unit in damp locations, otherwise it may cause short-circuit or corrosion of some components. The unit should be free from corrosive and moisture surrounding. Otherwise the lifetime of the unit might be shortened.
- 10) Please ensure enough space around the monoblock unit, for better ventilation and maintenance.  
Please refer to the illustration below.

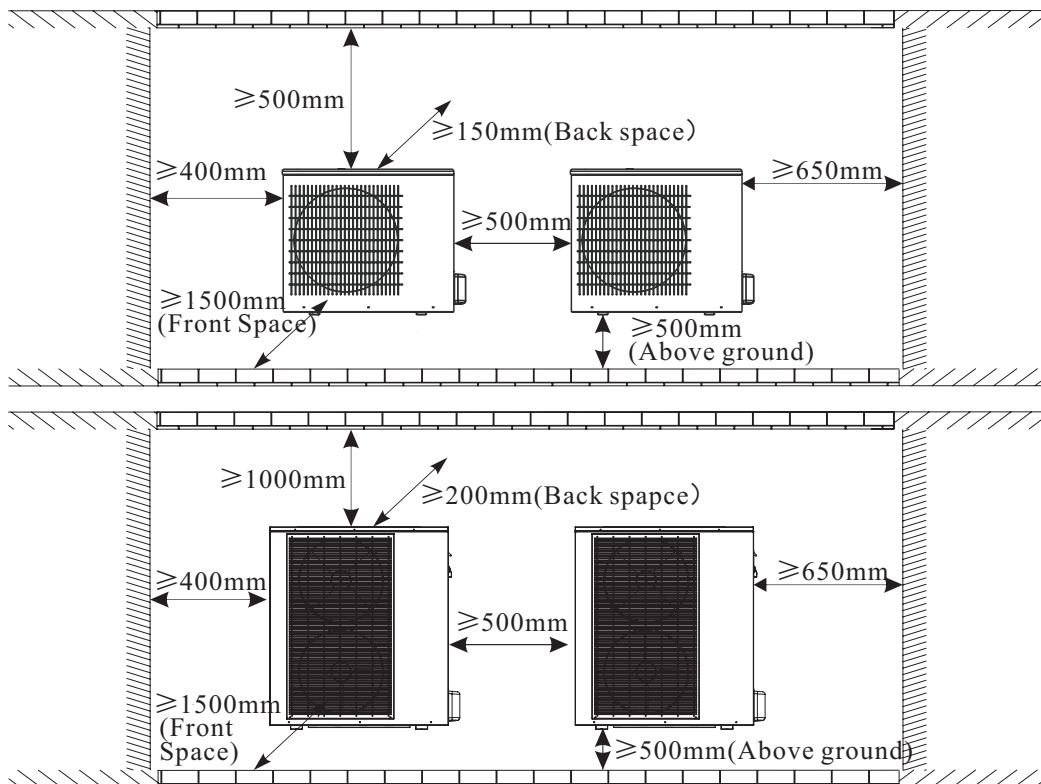

## 2. Installation

### 2.2.2 Installation

User can either use the dedicated mounting bracket from the supplier, or prepare a suitable bracket for the unit installation. Make sure the installation meets following requirements:

- 1) The unit must be installed on flat concrete blocks, or a dedicated mounting bracket. The bracket should be able to support at least 5 times of unit's weight.
- 2) All nuts must be tightened after the bracket is fixed; otherwise, it may cause damage to the equipment.
- 3) User should double check and make sure the installation of unit is firm enough.
- 4) The bracket can be of stainless steel, galvanized steel, aluminum and other materials as required by the user.
- 5) Besides the mounting bracket, the user can also install the monoblock unit on two concrete blocks, or a raised concrete platform. Please make sure that the unit is securely fastened after installation.
- 6) Please see the dimensions of monoblock unit when choose a suitable wall bracket.

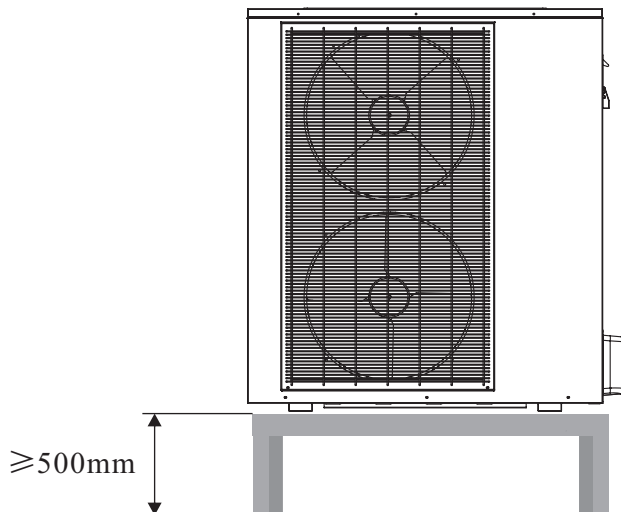

- ◆ Hole for piping kits should lean to outside a little bit ( $\geq 8$  degrees), to keep rain water or condensate water from flowing back indoors.

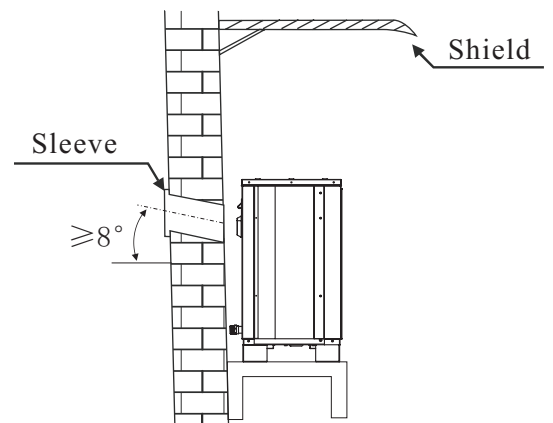

## 2. Installation

### 2.3 Accessories



Accessories below are delivered together with the product .  
Please check in time. If there is any shortage or damage, please contact local distributor.

Name	Quantity	Picture
Manual	1	

Name	Quantity	Picture
TR – Room temperature sensor	1	
TC-water temperature sensor for cooling TH-water temperature sensor for heating TW-water temperature sensor for Hot Water	1	
Communication cable between monoblock unit and operation panel	1	
Extension Cable (10 meters as standard)	4	

## 2. Installation

---

### 2.4 Wiring

- ◆ It is recommended to use a suitable circuit breaker for the heat pump;
- ◆ The power supply to the heat pump unit must be grounded.
- ◆ The wiring should be done by professional person.
- ◆ The wiring should be comply with the local industry regulation.
- ◆ The wiring should be done after the unit is powered off.
- ◆ Cable should be fixed tightly, to ensure it won't get loose.
- ◆ Don't connect several parts of cables together to use.
- ◆ Make sure the power supply in the local coincide with the power supply marked in rating label.
- ◆ Make sure power supply, cable and socket can meet the requirement of the input power of the unit.



## 2. Installation

### 2.4.1 Monoblock unit power supply.

Get a power cable in suitable length that complies to the local safety regulations.

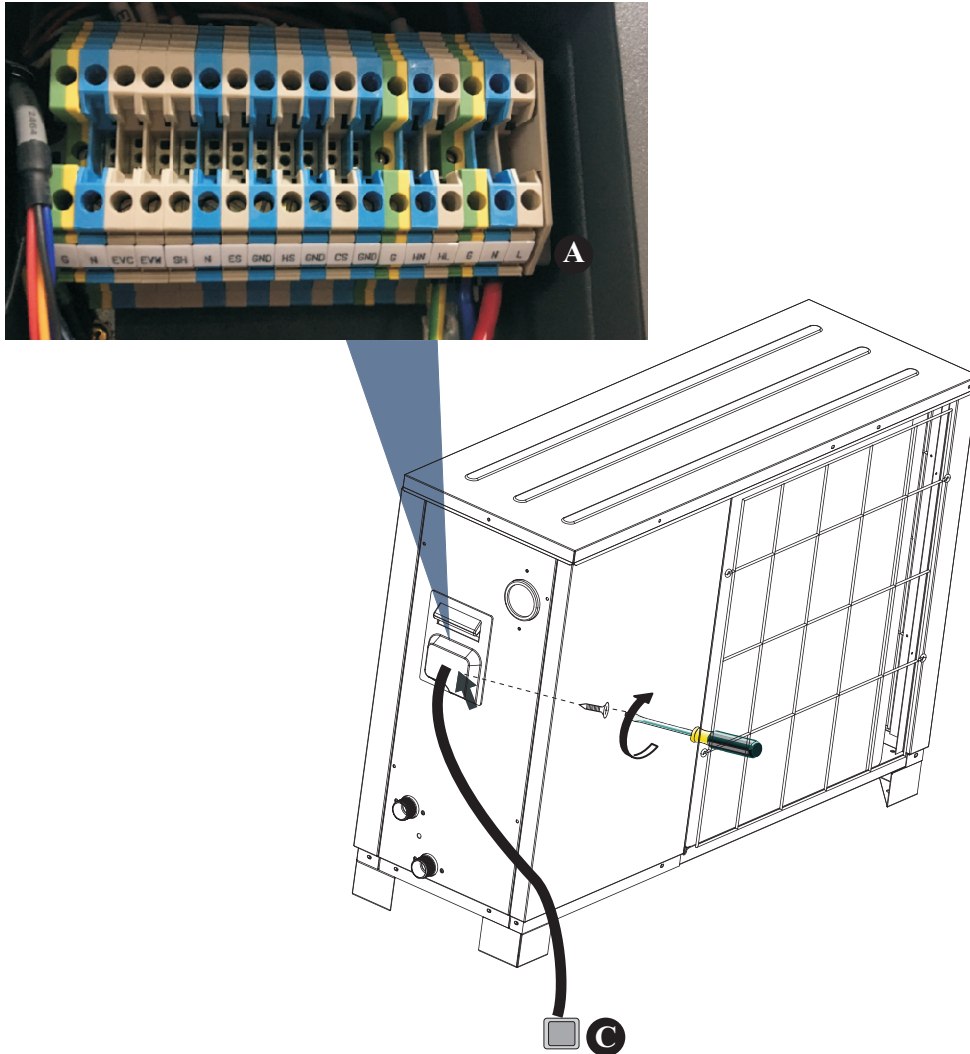

- A. Insert one end of this cable through the cable gland on back of the outdoor control unit, and connect it with heat pump power supply terminals (G, N, L).
- B. Fasten the cable gland to ensure the cable won't get loosen.
- C. Connect the other end to the city power supply.



## 2. Installation

### 2.4.2 Sensor cables

Take all sensors and communication cables out from the accessories bag. Connect the sensors together with the quick connectors on communication cables. After done, insert communication cables (the end without quick connector) that have no quick connector through cable gland, and connect them to the correspondent terminals on terminal block.

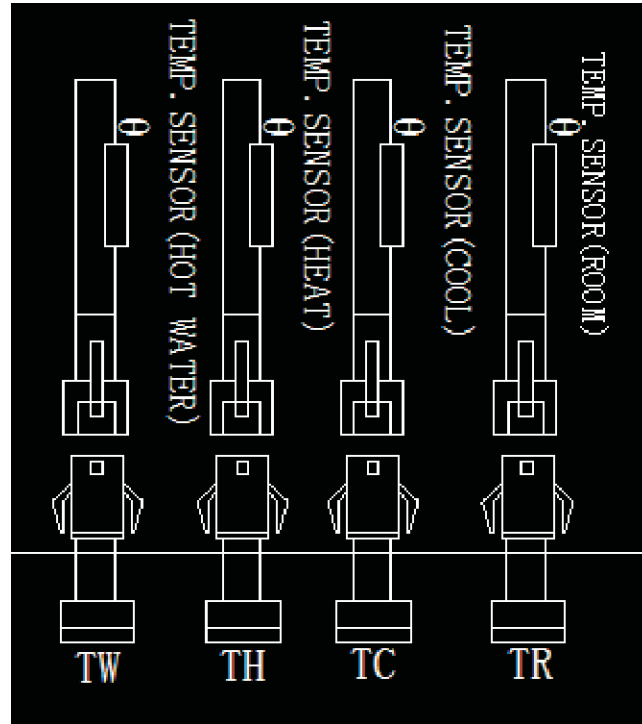

A	TC-water temperature sensor for cooling TH-water temperature sensor for heating TW-Water temperature sensor for hot water	Connect these sensors with communication cables by quick connector, and then connect communication cable (the end without quick connector) with terminal block. (These sensors are packed inside the accessories bag).
	TR-Room temperature sensor	

## 2. Installation

### 2.5 Water pipe connection

After installing the unit, please connect the water inlet and outlet pipe according to the local regulations. Please carefully select and operate the water pipe.

After connection, the water piping should be pressure tested, cleaned before use.

#### 1) Filter

A mesh filter must be installed in front of the water inlet of the unit and water tank, to keep the water quality and collect impurity contained in the water. Take care to keep the water filter mesh towards the bottom. Check valve is recommended to be installed at both sides of the filter, so as to clean or change the filter in a easier way.

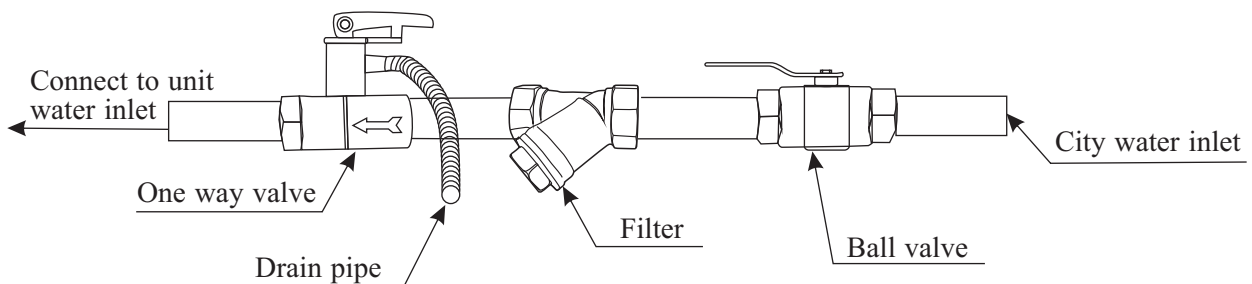

#### 2) Insulation

All pipes running hot water should be well insulated. The insulation must be tied up tightly without gap (But please don't wrap up the check valve for future maintenance).



Please ensure enough water pressure to send the water to the required height.  
If the water pressure is not enough to maintain proper water flow rate for the system, please add a water pump to increase the pumping head.

#### 3) Requirements of water quality

- A. Chloridion element in the water should be less than 300ppm(temperature is less than 60°C).
- B. PH value of water should be from 6 to 8.
- C. The water with ammonia can't be used for the unit.

If the water quality is bad, or water flow too little, scale formation or clogging may happen after unit running for a long time, then the efficiency of cooling or heating will be low or the unit will work abnormally.

Please clean water before use, or use purified water. Make sure the water quality is good enough to keep the unit long-term running in high efficiency.

## 2. Installation

### 2.6 Test run



**After installation finished, please fulfill the water system with water and purge out air in the system before start-up.**

#### 1) Before start-up

Before the unit starts up, a certain number of verifications must be performed on the installation to ensure that the unit will operate under the best possible conditions. The check list below is not exhaustive and should only be used as a minimum reference basis:

- A. Make sure fan rotates freely;
- B. Inspect all water piping for flow direction;
- C. Verify all system piping is correct for operation as per installation requirements;
- D. Check voltage of the unit power supply and make certain voltage is within authorized limitations;
- E. Make sure the unit is properly grounded;
- F. Check the presence of protective and breaking devices;
- G. Check all electric connections for tightness.
- H. Check all piping for leaks and air is well ventilated.



**If everything above is OK, the unit can start up.**

**If any of them fails, please fix it.**

#### 2) Pre-start up

- A. When the installation of unit is completed, water system pipes are well connected and air purging is done, no leakage or other problems, the unit can be powered to start up.
- B. Turn on the unit, press the on-off button on the operation panel to start the unit. Please check carefully if there is some abnormal noise or vibration, or the display of wired controller is normal or not.
- C. After the unit is working properly for 10 minutes, without any problem, then the pre-start up is completed; If not, please refer to the Service and Maintenance chapter in this manual to solve the problems.



**It is suggested not to run "heating" or "hot water" mode, when ambient temperature is over 32 °C, otherwise unit may go into protection mode easily.**





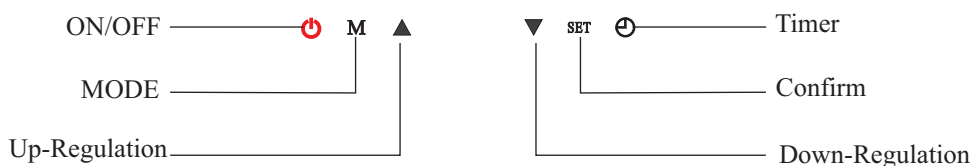
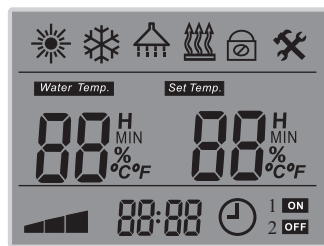

# 3. Usage

## 3.1 Introduction of wired controller



Symbol	Function	Explanation	Working mode
	Heating mode	When heating mode is selected, symbol is shown in the display	Symbol shown in display when selected, flickers when activated
	Cooling mode	When cooling mode is selected, symbol is shown in the display	Symbol shown in display when selected, flickers when activated
	Shower Water mode	When shower water mode is selected, symbol is shown in the display	Symbol shown in display when selected, flickers when activated
	Auxillary heater step 1 and step 2	When auxillary heater is connected and activated, symbol is shown in the display	Symbol flickers when step 1, 2 or both are "ON"
	Anti freezing protection	Self protection function to avoid freezing when ambient temperature drops and unit is in "OFF" mode. (Not adjustable)	Constantly lights for primary anti-freezing protection. Flickers for secondary anti-freezing protection.
	Anti legionella function	Increases the shower water temperature with electric heater weekly to kill bacterias	Symbol starts flickering when function is "ON"
<b>Water Temp.</b>	Actual water temperature	Shows the actual water temperature in according to units operation mode	Always "ON" when unit is "Water Control" Always "OFF" when unit is "Room Control"
<b>Set Temp.</b>	Actual set temperature	Shows the actual set temperature in according to units operation mode	Always "ON" when unit is "ON"
<b>H</b>	Heat recovery function	Not available for this model	
<b>MIN</b>	Quiet operation	Lower the working speed of compressor and fan motors in selected time periode	When activated this symbol is "ON"
<b>%</b>	Defrosting	Deicing the outdoor unit evaporator when ice is build up. (Self learning, not adjustable)	When defrosting is activated this symbol is "ON". For dual compressor system: left symbol = system 2, right symbol = system 1.
<b>°C °F</b>	Degrees in Celsius of Fahrenheit	Shown when digits is correspondent with temperatures	
<b>88 88</b>	Operation values	Shows selected temperature values when unit is on or parameter setting values	When parameter setting is selected, values are shown in accordance to the parameter setting menu

### 3. Usage

Symbol	Function	Explanation	Working mode
	Compressor indicator	Indicates the current working level, "low range30-46", "middle range47-65", "high range66-100"	If symbol is "ON" compressor is working
	Clock or parameter indicator	Clock and parameter menu and group indicator	Shows time when unit is "ON", Shows parameter groupe or -number when unit is "OFF" and parameter setting is selcted
	Timer	Indicates that one or more operation timer parameters is selected	When "ON" means unit is "OFF" until the selected time where unit is set to be "ON"
1	Timer Shower water	Indicates that shower water is set to "Timer" operation, and weather it is in "ON" periode and if unit actually is working in this mode.	"1" shows that "Timer" for shower water mode is selcted and that unit is within its "ON" periode. "ON" indicates that unit is actually working in shower water mode
2	Timer heating/cooling	Indicates that heating/cooling mode is set to "Timer" operation, and weather it is in "ON" periode and if unit actually is working in this mode.	"2"shows that "Timer" for heating/cooling mode is selcted and that unit is within its "ON" periode. "OFF" indicates that unit is not working in heating/cooling mode at the moment
	ON/OFF	Button switch the entire unit on and off	Button also have some parameter setting functions
M	Operation mode selector	Button switch between basic operation modes, Heating/cooling/shower/water, and different combinations of these	Button also have some parameter setting functions
	UP value	Button increases set temperature, switch between parameters or adjust set value in parameter setting menu	Button also have some parameter setting functions
	Down value	Button decareses set temperature, switch between parameters or adjust set value in parameter setting menu	Button also have some parameter setting functions
SET	Set button/Clock	Button activates the unit for changing in set values in temperatures or parameters and button enters clock setting when the unit "OFF"	Button also have some parameter setting functions
	Timer button	timer settings	Button also have some parameter setting functions

## 3. Usage

### ■ 3.2 Parameter Setting Overview

Item	Sub-menu	Unit Statue Under	Operation Level	Page in the menu	Default factory settings
Clock Time	None	OFF	User	24	00:00
Temp. Setting	Hot water/Heating/Cooling	ON	User	24	
Working Mode	Hot water, heating, cooling, hot water+heating, hot water+cooling, heating+cooling, hot water+heating+cooling	ON	User	24	
Room Temp. Control		ON	User	25	20°

No matter the unit is ON or OFF, press  $\odot$  button to check or activate "Timer" parameter setting. Use  $\blacktriangle$  or  $\blacktriangledown$  button to view all parameters in sequence. When the value of a parameter needs to be adjusted, press "SET" when this parameter is shown to activate the setting of this parameter. The value start flickering.

Use  $\blacktriangledown$  button to adjust the value, or  $\blacktriangle$  button to adjust setting in "hours",  $\blacktriangledown$  button to adjust the setting in "minutes", if this parameter is a time parameter.

Item	Sub-menu	Unit Statue	Operation Level	Page in the menu	Default factory settings
Timer Parameter	Timer function ON/OFF	ON/OFF	User	25	0 (OFF)
	Hot Water Timer ON-1			28	00:00
	Hot Water Timer OFF-1				00:00
	Hot Water Timer ON-2				00:00
	Hot Water Timer OFF-2				00:00
	Heating/Cooling Timer ON-1				28
	Heating/Cooling Timer OFF-1			00:00	
	Heating/Cooling Timer ON-2			00:00	
	Heating/Cooling Timer OFF-2			00:00	
	Normal Shower Time (for unit with heat recovery function only)			29	00:00
	Anti-legionella function			29	00:00
	Anti-legionella function starting time				00:00
	Pump anti-block running time				00:00
	Quiet operation starting time				00:00
Quiet operation ending time	00:00				

### 3. Usage

All the units sensor values (temperatures) and information of current running status (compressor speed, voltage and current) can be read and checked via operation panel in both ON/OFF status. Press ▲ and ▼ buttons for 5 seconds in main interface, to activate the menu of current running status. Press ▲ or ▼ buttons to check all working status in sequence in accordance to below list. The current number is displayed where the clock is displayed in main interface. See operation panel symbols in page...

Item	Meaning	Item	Meaning
1	DHW Set Temp	19	System 2 evaporating pressure
2	Heating Set Temp	20	System 2 condensing pressure
3	Cooling Set Temp	21	System 2 EEV position
4	Room Set Temp	22	System 1 indoor coil temperature
5	Ambient temperature	23	System 1 voltage (V)
6	Hot water temperature	24	System 1 current (A)
7	Heating water temperature	25	System 1 compressor speed (Hz)
8	Cooling water temperature	26	System 1 outdoor coil temperature
9	Room temperature	27	System 1 comp. discharge temp.
10	Unit outlet temperature	28	System 1 suction temperature
11	Unit inlet temperature	29	System 1 evaporating pressure
12	System 2 indoor coil temperature	30	System 1 condensing pressure
13	System 2 voltage (V)	31	System 1 EEV position
14	System 2 current (A)	32	Water outlet Temp. Too High Protection
15	System 2 compressor speed (Hz)	33	Water outlet Temp. Too Low Protection
16	System 2 outdoor coil temperature	34	Indoor Unit Software Version
17	System 2 comp. discharge temp.	35	System 2 Outdoor Unit Software Version
18	System 2 suction temperature	36	System 1 Outdoor Unit Software Version

User level Parameter under basic operation level can be set in "OFF" mode only. Press "SET"+"M" for 5 seconds, Parameter will shown on the display. Press ▲ or ▼ to check parameter values for each parameter in sequence.

Item	Sub-menu	Unit Statue	Operation Level	Page in the menu	Default factory settings
User level Parameter	Hot Water restart based on water $\Delta T$	Check in ON/OFF, Set in OFF	User	30	5°
	Heating restarts based on water $\Delta T$			30	2°
	Cooling restarts based on water $\Delta T$				2°
	Cooling and heating switch judgment				0 (OFF)

### 3. Usage

Item	Sub-menu	Unit Statue	Operation Level	Page in the menu	Default factory settings
Temperature Parameter	Ambient temp. to start heating	Check in ON/OFF, Set in OFF	User	31	20°
	Ambient temp. to start cooling				25°
	Shifting priority			31	100°
	Set room temperature				20°

1.Code input: When unit is in "OFF" mode, press ▼ for 5 seconds, "----" will be shown. Press ▲ to swfit between 4 positions, and press ▼ to adjust the value of the blinking value. Press "SET" to confirm the input password. If the password is correct, "Advanced Setting" mode is activated.

2.Complete Advanced Setting menu is divided into 6 groups (Group 0~Group E). When Advanced Setting menu is activated, press ⊙ to switch between each group(Group 0, A, B, C, D,E) .

3.Press ▲ or ▼ to switch different parameters in the same group. Press "SET" to activate setting of current parameter, with its value blinks, and adjust its value by ▲ or ▼ . Press "SET" to confirm the setting.

Item	Sub-menu	Unit Statue	Operation Level	Page in the menu	Default factory settings
Advanced Setting Group 0	Test working mode indoor controller	OFF	Installer	36	0 (Normal operation)
	External ON/OFF switch			37~38	0 (Invalid)
	Water flow switch				60 sec
	Heating buffer tank				0 (No)
	Cooling buffer tank				0 (No)
	Priority switch between hot water and heating operation			39	0 (hot water)
	Refrigerant collecting function				0 (OFF)
	Lock Function				00 (OFF)
	Available working modes			40	2(all functions)
	Stop/Speed down ΔT based on set temperature in heating/cooling				2°C
	Max Allowed Duration For Min Compressor Speed				30 min
	Advanced Setting Group A			Unit Circulation Pump Control Type	OFF
Heating Circulation Pump Control Type		42	0 (unit controlled)		
Cooling Circulation Pump Control Type			0 (unit controlled)		
Heating Circulation Pump Start Temperature			20°		
Heating Cirulation Pump Stop Temperature			18°		
Cooling Circulation Pump Start Temperature			18°		
Cooling Cirulation Pump Stop Temperature			20°		



### 3. Usage

Item	Sub-menu	Unit Statue	Operation Level	Page in the menu	Default factory settings
Advanced Setting Group A	Unit Motorized 3-way valve Switching Time	OFF	Installer	43	120 sec
	Heating Operation Motorized 3-way valve Direction				1 same as cooling operation
Advanced Setting Group B	Anti-Legionella Set Temperature	OFF	Installer	43	60
	Anti-Legionella Duration				30 min.
	Anti-Legionella Maximum Allowable Working Duration				120 min.
	Anti-freezing Function			43	1 (ON)
	Anti-freezing Starting Ambient Temperature--Primary				5°
	Anti-freezing Starting Ambient Temperature--Secondary				2°
	Anti-freezing Ending Ambient Temperature--Secondary				5°
	Anti-freezing Starting Water Temperature--Secondary				2°
	Anti-freezing Ending Water Temperature--Secondary				15°
Advanced Setting Group C	Manual ON/OFF of Heater in Hot Water Mode	OFF	Installer	44	0 (OFF)
	Backup Heating Source For Hot Water Mode				0 (No)
	Priority Of Backup Heating Sources For Hot Water Mode (Compared With Unit Auxiliary Heater)				0 (lower)
	Temperature Increasement Checking Duration in Hot Water Mode				40
	Maximum Allowable Set Water Temperature in Heating Mode				42
	Manual ON/OFF of Heater in Heating Mode				0 (OFF)
	Backup Heating Source For Heating Mode			44	1 (Yes)
	Priority Of Backup Heating Sources For Heating Mode (Compared With Unit Auxiliary Heater)				1 (Higher)
	Accumulated Value between operation time VS set temp. for Heating Mode				45
Advanced Setting Group D	Heating Curve Function	OFF	Installer	44	1 (ON)
	Room Temp. Effect On Heating Curve			44	0 (OFF)



### 3. Usage

Item	Sub-menu	Unit Statue Under	Operation Level	Page in the menu	Default factory settings
Advanced Setting Group D	Ambient Temp. 1	OFF	Installer	45	12
	Ambienttemp 1 Vs Water Temp. 1				25
	Ambient Temp. 2				7
	Ambienttemp 2 Vs Water Temp. 2				28
	Ambient Temp. 3				2
	Ambienttemp 3 Vs Water Temp. 3				31
	Ambient Temp. 4				-7
	Ambienttemp 4 Vs Water Temp. 4				35
	Ambient Temp. 5				-20
	Ambienttemp 5 Vs Water Temp. 5				42
Advanced Setting Group E	Heat Recovery Function	OFF	Installer	45~46	0 (Invalid)
	Hot Water Restart Based On $\Delta T$ in Heat Recovery Operation				5°
	Hot Water Stop Based On $\Delta T$ in Heat Recovery Operation				5°
	Allowable Temp Drift In Heating in Shifting Priority Operation			46	5
	Heating Max. Working Hours in Shifting Priority Operation				30
	Hot Water Min. Working Hours in Shifting Priority Operation				50
	Working of Extra Heating Source for Hot Water in Shifting Priority Operation				0 (No)

# 3. Usage



## 3.3 Basic Operation

### 【ON/OFF】

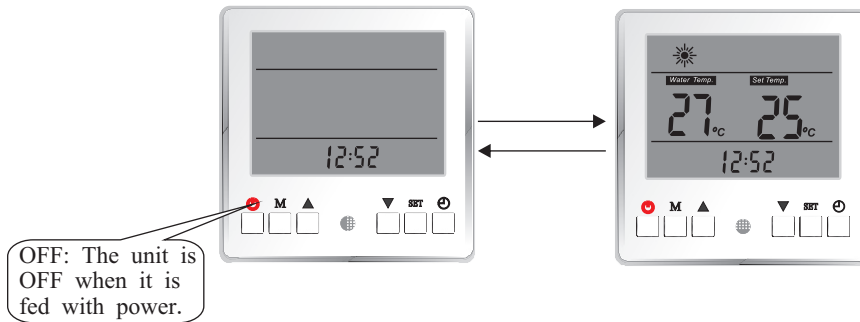
When the unit is OFF, press  to turn on the unit. The unit will work in its last working mode. Press  again to turn off the unit.



### 【Clock time setting】



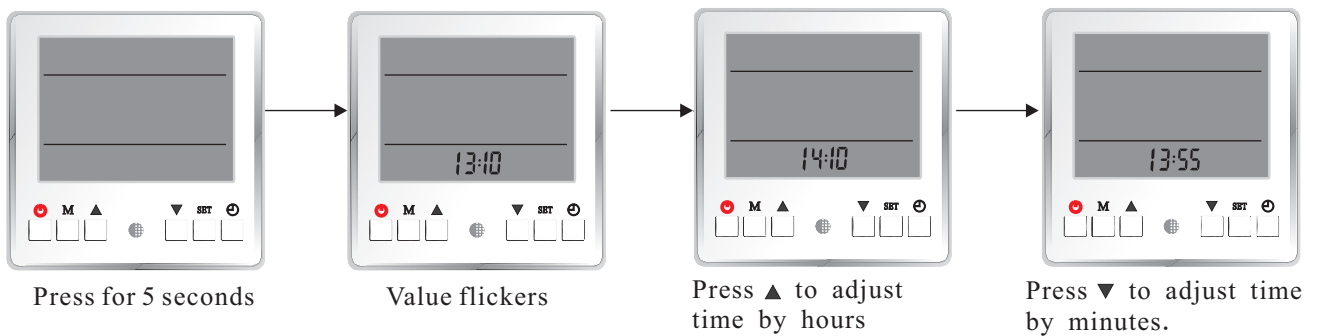



When the unit is in OFF mode, press "SET" for 5 seconds, to activate clock time setting, with the value flickers. Press  to adjust time by hours; press  to adjust time by minutes.



### 【Working modes setting】

Chose working mode settings in accordance to your heating/hot water/cooling system.

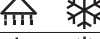
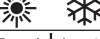
When the unit is ON, press "M" to set the unit working mode. For each time "M" is pressed working mode is changed by the below sequence. When a working mode is selected, its symbol(s) will be shown on the screen. The current working mode of the unit, is shown by a flickering working mode symbol.

Working Modes	Symbols
Hot water	
Heating only	
Cooling only	
Hot water+Heating	
Hot water+Cooling	
Auto	
Hot water+Auto	

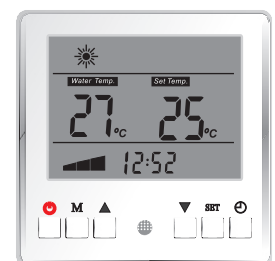

Picture shows that heating and hot water mode is selected

# 3. Usage

## 【Room Temperature Control】

When unit is ON, keep on pressing "M" to switch the control of cooling and heating operation between room temperature control and water temperature control mode.

When in water temperature control mode, "Water Temp." will be shown on the screen ;

When in room temperature control mode, "Water Temp." will not be shown on the screen.

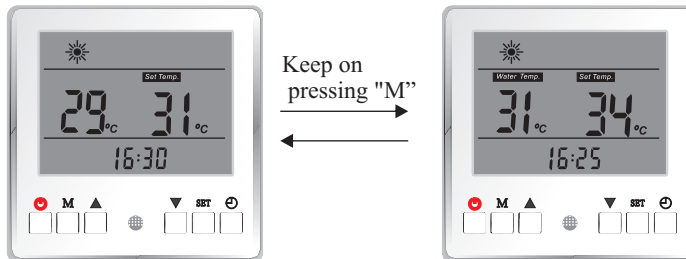

Room temperature control mode

Water temperature control mode

**Note:**

**If unit is set to Hot Water mode only, or unit is set to combined working mode but unit is working in hot water mode, this operation is invalid.**

## 【Temperature setting】

### Single working mode

When unit is on and working mode is selected, press “set” to activate the temperature setting. Working mode symbol flickers.

Adjust the set temperature by:

Press ▲ to increase the set temperature by 1°C.

Press ▼ to decrease the set temperature by 1°C.

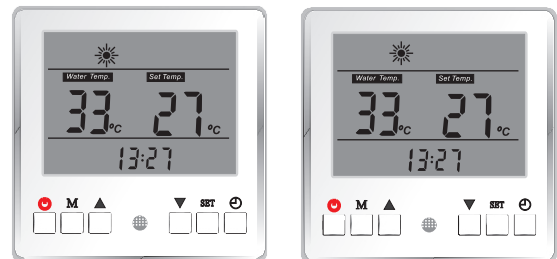

### Combined working mode

When combined working mode is selected, unit will switch between selected working modes. For example heating + hot water, unit will switch between space heating and hot water operation. Press “set” to activate the temperature settings. The working mode symbol that is being adjusted, flickers. Adjust the temperature setting by using the ▲/▼ arrows.

Press “set” to confirm the setting, and activate following working modes temperature setting, with its working mode symbol flickers. Adjust the temperature setting by using the ▲/▼ arrows.

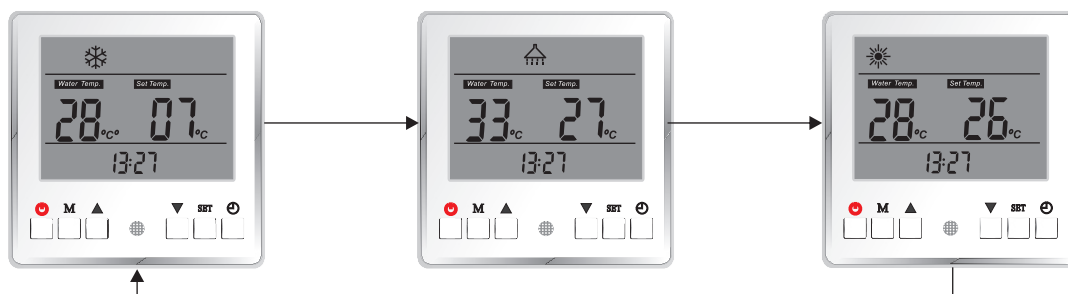

Press "SET" to switch the temperature setting between selected working modes in sequence.

**Note:1. If heating curve function is activated, set temperature for heating will be calculated according to the set curve automatically. Its set temperature can't be adjusted by this operation.**

**2. If room temperature control mode is activated, temperature set here for heating and cooling is based on room temperature.**

## 3. Usage

### 【Time&Timer Setting】

Timer function allows you to control different working modes at specific hours during a 24 hour period, for even more energy savings. For example you can turn off hot water production in the daily hours you don't use this. In the selected period unit will not produce hot water even hot water is selected as working mode in your application. The setting is repeated every 24 hours until it is deactivated.

#### Parameter list

Parameter No.	Meaning	Range	Default Value
0	Timer function ON/OFF	0(off), 1(on)	0
1	Hot Water Timer ON-1	00 00-23 59	00 00
2	Hot Water Timer OFF-1	00 00-23 59	00 00
3	Hot Water Timer ON-2	00 00-23 59	00 00
4	Hot Water Timer OFF-2	00 00-23 59	00 00
5	Heating/Cooling Timer ON-1	00 00-23 59	00 00
6	Heating/Cooling Timer OFF-1	00 00-23 59	00 00
7	Heating/Cooling Timer ON-2	00 00-23 59	00 00
8	Heating/Cooling Timer OFF-2	00 00-23 59	00 00
9	Normal Shower Time (for unit with heat recovery function only)	00 00-23 59	00 00
10	Anti-legionella function	0(off), 1(on)	0
11	Anti-legionella function starting time	00 00-23 59	00 00
12	Pump anti-block running time	00 00-23 59	00 00
13	Quiet operation starting time	00 00-23 59	00 00
14	Quiet operation ending time	00 00-23 59	00 00

No matter the unit is ON or OFF, press  $\odot$  to check or activate "Timer" parameter setting, which looks as shown below:

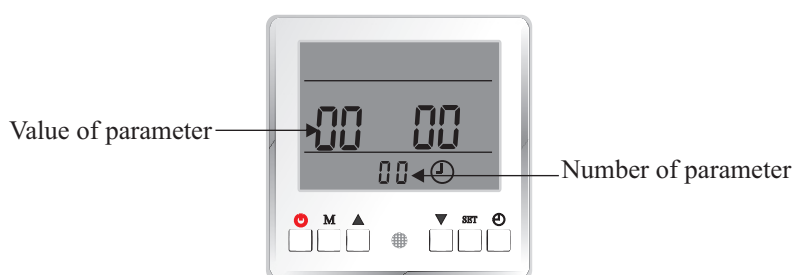

Parameter 00, value=0000

Use  $\blacktriangle$  or  $\blacktriangledown$  to view all parameters in sequence. When the value of a parameter needs to be adjusted, press "SET" when this parameter is shown to activate the setting of this parameter. The value starts flickering.

Use  $\blacktriangle$  to adjust setting in hours,  $\blacktriangledown$  to adjust the setting in minutes" if this parameter is a time parameter

### 3. Usage

For example, parameter 00 is to set the ON/OFF of complete timer function (if it is set to OFF, following parameters 01~08 will be invalid). When setting for this parameter is activated, use ▼ to adjust the value.

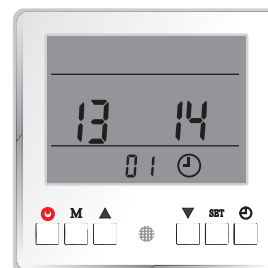

For example, parameter 01 is the ON time for hot water function. When setting for this parameter is activated, press ▲ to adjust the setting in hours; press ▼ to adjust the setting in minutes” for parameter that relates to time

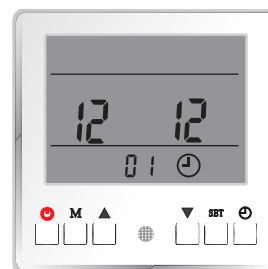

#### Meaning of each parameter

Timer setting parameter 0 to 8.

To be able to activate timer setting for parameter 1 to 7, parameter 0 needs to be activated first.

Parameter No.	Meaning	Range	Default Value
0	Timer function ON/OFF	0(off), 1(on)	0

Hot Water Timer:

Parameter No.	Meaning	Range	Default Value
1	Hot Water Timer ON-1	00 00-23 59	00 00
2	Hot Water Timer OFF-1	00 00-23 59	00 00
3	Hot Water Timer ON-2	00 00-23 59	00 00
4	Hot Water Timer OFF-2	00 00-23 59	00 00

These parameters are used for setting the ON/OFF timer for hot water operation. After setting, unit will only activate hot water operation in the selected period(s).

For example, if the below setting is set; domestic hot water will only be heated up during the period 04:00~09:00, and 14:00~21:00 every day.

Parameter No.	Meaning	Value
1	Hot Water Timer ON-1	04 00
2	Hot Water Timer OFF-1	09 00
3	Hot Water Timer ON-2	14 00
4	Hot Water Timer OFF-2	21 00

For how to make the setting, please refer to previous page.

### 3. Usage

Heating/Cooling Timer:

Parameter No.	Meaning	Range	Default Value
5	Heating/Cooling Timer ON-1	00 00-23 59	00 00
6	Heating/Cooling Timer OFF-1	00 00-23 59	00 00
7	Heating/Cooling Timer ON-2	00 00-23 59	00 00
8	Heating/Cooling Timer OFF-2	00 00-23 59	00 00

These parameters are used for setting the ON/OFF timer for heating or cooling operation. After setting, unit will only activate heating or cooling operation, when needed, in the set timer period. For example, below setting is made

Parameter No.	Meaning	Value
5	Heating/Cooling Timer ON-1	00 00
6	Heating/Cooling Timer OFF-1	08 00
7	Heating/Cooling Timer ON-2	17 00
8	Heating/Cooling Timer OFF-2	23 59

Then heat pump will only heat or cool the house during the period 00:00~08:00, and 17:00~23:59 every day.

When timer function is activated, following symbols might be shown on the screen:

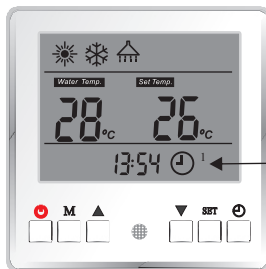

This symbol means the unit is in sanitary hot water Timer ON period. Unit will work in hot water mode when needed.

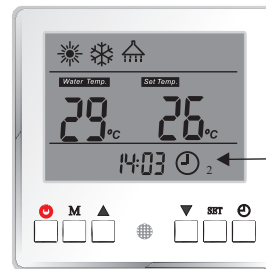

This symbol means the unit is in cooling/heating Timer ON period. Unit will work in cooling/heating mode when needed.

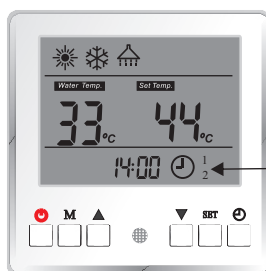

This symbol means the unit is in sanitary hot water and cooling/heating Timer ON period. Unit will work for both hot water and cooling/heating mode (not in same time) when needed.

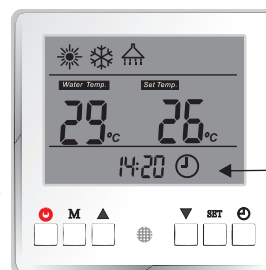

This symbol means the unit is neither in hot water nor cooling/heating Timer ON period. Unit will not work for both hot water and cooling/heating mode even needed.

Normal Shower Time:

Parameter No.	Meaning	Range	Default Value
9	Normal Shower Time (for unit with heat recovery function only)	00 00-23 59	00 00

This parameter is designed for the unit with heat recovery function only. When using recovered heat to heat up sanitary hot water, it is not always enough to heat up the shower water. If 1 hour before this "Normal Shower Time" set time is reached, hot water temperature has still not reached the set value, unit will activate standard hot water operation to ensure you can enjoy enough hot shower water at/after this time.

### 3. Usage

For example, if the setting is made like below:

Parameter No.	Meaning	Value
9	Normal Shower Time (for unit with heat recovery function only)	20 00

If at time 19:00 in the day, shower water is still not enough for shower, unit will activate standard hot water operation, instead of using recovered heat to heat up the shower water.

Anti-legionella function

Parameter No.	Meaning	Range	Default Value
10	Anti-legionella function	0(off), 1(on)	0
11	Anti-legionella function starting time	00 00-23 59	00 00

Parameter 10 is used to activated or deactivate Anti-legionella function.

Parameter 11 is used to set the starting time of Anti-legionella function.

During the hot water operation, unit will record the highest hot water temperature it produced. If in 7\*24 hours time period, unit has not reached the set water temperature for "anti-legionella function" (set in Advanced Menu) even once, then unit will activate anti-legionella operation at "Anti-legionella function starting time".

For details for "anti-legionella" function, please contact your installer or read chapter "Advanced Opeartion" in our manual.

Pump anti-block running time

Parameter No.	Meaning	Range	Default Value
12	Pump anti-block running time	00 00-23 59	00 00

Circulation water pump may easily get blocked if it has not working for long time. In order to avoide this from happening, circulation water pump will be activated for 1 minute, if it is not working at this set clock time every day.

Quiet operation

Parameter No.	Meaning	Range	Default Value
13	Quiet operation starting time	00 00-23 59	00 00
14	Quiet operation ending time	00 00-23 59	00 00

Thanks for the DC technology applied in this system, unit can lower both its compressor speed and fan rotating speed, to get a ultra low noise operation in this set time period.

#### 【Temperature Info】

All temperature information of current running statue can be checked via operation panel in both ON/OFF status.

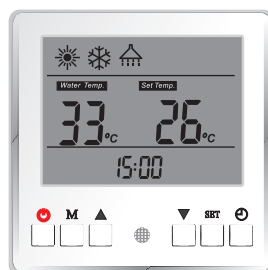

Press ▲ and ▼ for 5 seconds in main interface, to activate inquiry of current running status.

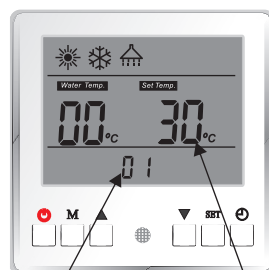

Number of parameter

Value of parameter

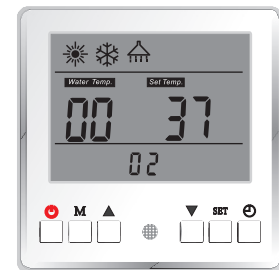

Press ▲ or ▼ to check all working status in sequence.



# 3. Usage

## Meaning of all readings:

Item	Meaning	Item	Meaning
1	DHW Set Temp	19	System 2 evaporating pressure
2	Heating Set Temp	20	System 2 condensing pressure
3	Cooling Set Temp	21	System 2 EEV position
4	Room Set Temp	22	System 1 indoor coil temperature
5	Ambient temperature	23	System 1 voltage (V)
6	Hot water temperature	24	System 1 current (A)
7	Heating water temperature	25	System 1 compressor speed (Hz)
8	Cooling water temperature	26	System 1 outdoor coil temperature
9	Room temperature	27	System 1 comp. discharge temp.
10	Unit outlet temperature	28	System 1 suction temperature
11	Unit inlet temperature	29	System 1 evaporating pressure
12	System 2 indoor coil temperature	30	System 1 condensing pressure
13	System 2 voltage (V)	31	System 1 EEV position
14	System 2 current (A)	32	Water outlet Temp. Too High Protection
15	System 2 compressor speed (Hz)	33	Water outlet Temp. Too Low Protection
16	System 2 outdoor coil temperature	34	Indoor Unit Software Version
17	System 2 comp. discharge temp.	35	System 2 Outdoor Unit Software Version
18	System 2 suction temperature	36	System 1 Outdoor Unit Software Version

## 【User level Parameter】

User level Parameter under basic operation level can be checked in both ON and OFF mode.

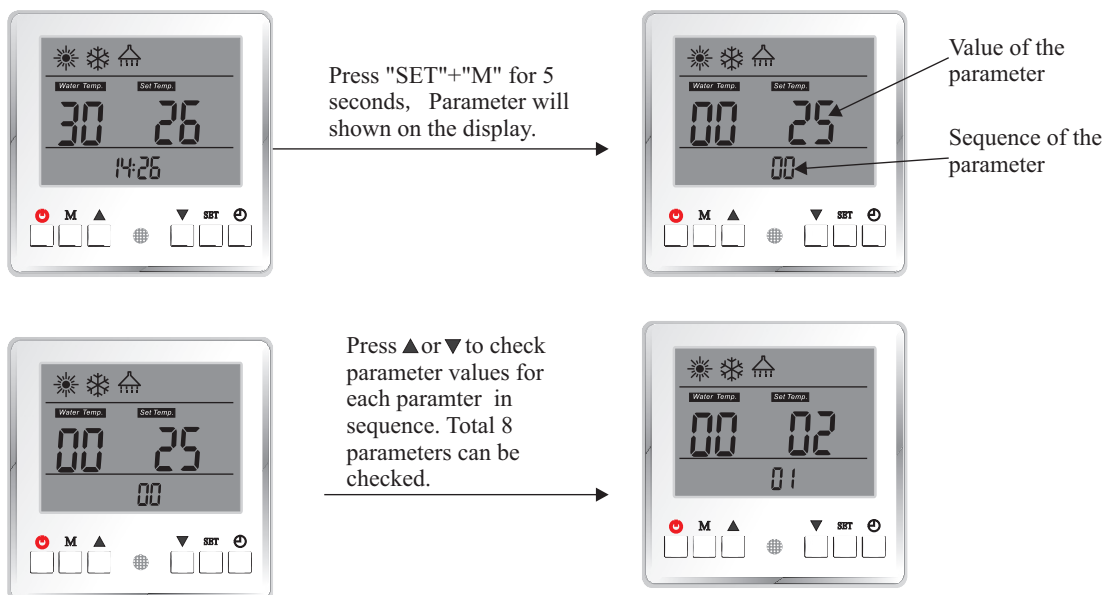

### 3. Usage

Temperature Parameter under basic operation level can be set in "OFF" mode only.

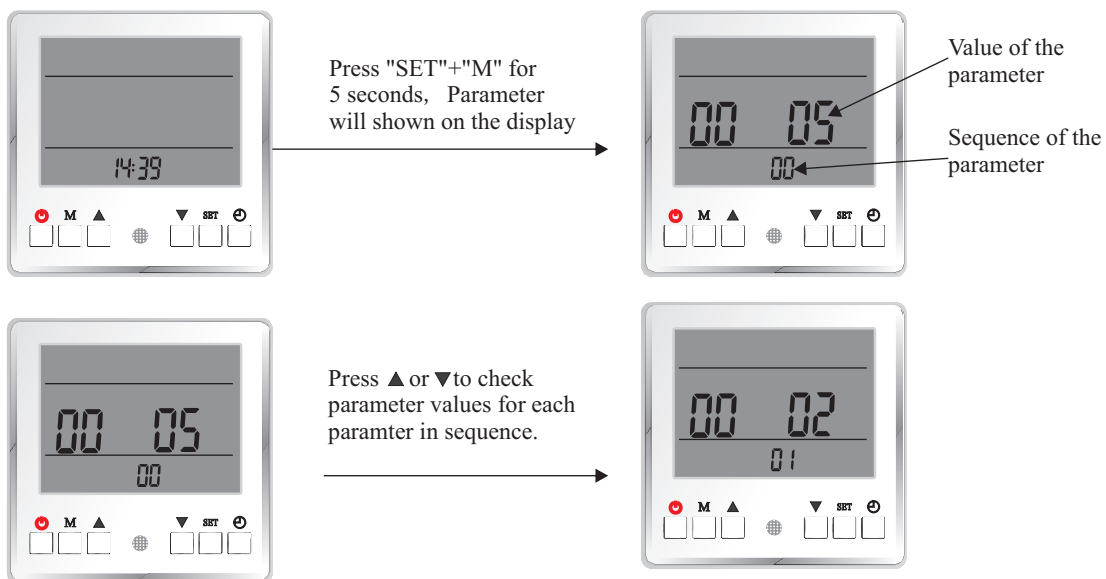

Press "SET" to activate setting of current parameter, with its value blinks.

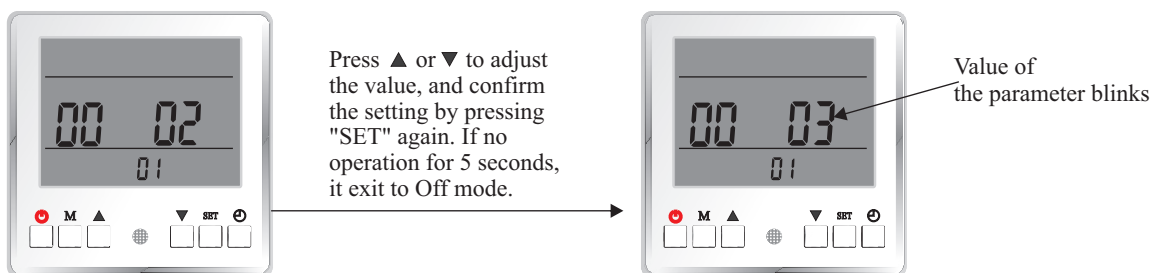

In OFF mode, default parameter settings of factory can be recovered by pressing "M"+"▲".

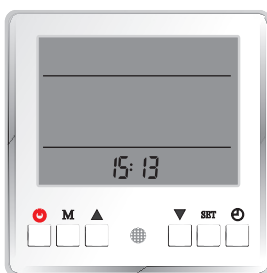

## 3. Usage

List of parameters

Parameter No.	Meaning	Range	Default Value
0	Domestic Hot Water Restart Based On Water $\Delta T$	0 - 10 (in $^{\circ}\text{C}$ )	5
1	Heating Restarts Based On Water $\Delta T$	0 - 10 (in $^{\circ}\text{C}$ )	2
2	Cooling Restarts Based On $\Delta T$	0 - 10 (in $^{\circ}\text{C}$ )	2
3	Cooling and Heating Switch Judgment	0(via. Ambient Temp.), 1 (via. External Signal)	0
4	Ambient Temp. To Start Heating	-10 - 43 (in $^{\circ}\text{C}$ )	20
5	Ambient Temp. To Start Cooling	5 - 35 (in $^{\circ}\text{C}$ )	25
6	Shifting Priority	-20 -20, 100 (stands for invalid)	100
7	Set Room Temperature	10-31 (in $^{\circ}\text{C}$ )	20

### Meaning of each parameter

List of adjustable parameters in Temperature Parameter Setting menu:

Parameter No.	Meaning	Range	Default Value
0	Domestic Hot Water Restart Based On Water $\Delta T$	0 - 10 (in $^{\circ}\text{C}$ )	5
1	Heating Restarts Based On Water $\Delta T$	0 - 10 (in $^{\circ}\text{C}$ )	2
2	Cooling Restarts Based On $\Delta T$	0 - 10 (in $^{\circ}\text{C}$ )	2

### Domestic Hot Water Restart Based On $\Delta T$ :

After sanitary hot water is heated up to the set temperature, unit will stop sanitary hot water operation. It will activate sanitary hot water operation after temperature drops "Hot Water Restart Based On Water  $\Delta T$ " below set temperature.

### Heating Restart Based On $\Delta T$ :

After house heating temperature is heated up to the set temperature, unit will stop heating operation. It will activate heating operation after temperature drops "Hot Water Restart Based On  $\Delta T$ " below set temperature.

### Cool Restart Based On $\Delta T$ :

After house cooling temperature is cooled down to the set temperature, unit will stop cooling operation. It will activate cooling operation after temperature increases "Hot Water Restart Based On  $\Delta T$ " above set temperature.

Parameter No.	Meaning	Range	Default Value
3	Cooling and Heating Switch Judgment	0(via. Ambient Temp.), 1 (via. External Signal)	0
4	Ambient Temp. To Start Heating	-10 - 43 (in $^{\circ}\text{C}$ )	20
5	Ambient Temp. To Start Cooling	5 - 35 (in $^{\circ}\text{C}$ )	25

If "Auto" mode (unit operation mode, set by press "M" button) is set, unit needs to switch between cooling and heating automatically, either according to "ambient temperature" (parameter 3=0) or "external signal" (parameter 3=1). If setting= "via. Ambient Temp.", the system will automatically switch between cooling and heating functions, based on the outdoor ambient temperature: When Ambient temperature is lower than value set in parameter 4, unit activate heating operation. When Ambient temperature is higher than value set in parameter 5, unit activate cooling operation.

If setting="via. External Signal", an external room thermostat or central control system in the building can control the cooling or heating requirements by connecting it to the respective signal ports. The signals are simple 1-0 (on-off) signals

## 3. Usage

If cooling port receives the signal, the system switches to cooling; If heating port receives the signal, the system switches to heating. When neither port receives the signal, the system stays in standby mode.

**Note: If system has a very big buffer tank for both cooling and heating operation, please pay special attention to set "Auto" to "via Ambient Temperature". Otherwise it may waste lots of energy in Spring or Autumn, as unit may need to switch between cooling and heating operation quite often.**

Parameter No.	Meaning	Range	Default Value
6	Shifting Priority	-20 - 20, 100 (stands for invalid)	100

Air to water heat pump is an equipment that absorbs heat from surrounding air, and transfers it to water. The lower the ambient temperature is, the less heat the unit absorbs. This makes the unit heating capacity and efficiency drop when ambient temperature drops. The unit takes longer time to heat up the sanitary hot water. However, the lower the ambient temperature is, the more heat the house demands. If the unit does not provide enough heat while it is working for hot water, the temperature inside the house may drop too much, and people in it feels uncomfortable. So when this function is activated, unit tries to divide the working time for sanitary hot water into several cycles, after ambient temperature drops below this set value.

In Advanced Setting, there has more parametes related to the working of this function. For more details, please contact your installer or read chapter "Advanced Opeartion" in our manual.

**Note: If this parameter is set to 100, it means this function is invalid. If it is set to any value other than 100, that means this function is activated and start to shifting priority after ambient temperature drops below this set value.**

Parameter No.	Meaning	Range	Default Value
7	Set Room Temperature	10-31 (in °C)	20

Heating or cooling function has "Water Temperature Control" as default. However when a room temperature sensor is connected to the unit and a more precise control of room temperature where the sensor is placed is preferred, "Room Temperature Control" mode can be selected. And the ideal room temperature can be set via this parameter.

**Note:When "Room Temperature Control" mode is selected, system will not operate under the heating curve function and actual water temperature may swing significantly.**

### 【Heating Curve】

#### Group D

List of parameters

Parameter No.	Meaning	Range	Default Value
D1	Heating Curve Function	0(invalid), 1(valid)	1
D2	Room Temp. Effect On Heating Curve	0(invalid), 10 - 60(time period for every adjustment, in minutes)	0
D3	Ambient Temp. 1	-20 - 45 (in °C)	12
D4	Ambienttemp 1 Vs Water Temp. 1	20 - 65 (in °C)	25
D5	Ambient Temp. 2	-20 - 45 (in °C)	7
D6	Ambienttemp 2 Vs Water Temp. 2	20 - 65 (in °C)	28
D7	Ambient Temp. 3	-20 - 45 (in °C)	2
D8	Ambienttemp 3 Vs Water Temp. 3	20 - 65 (in °C)	31
D9	Ambient Temp. 4	-20 - 45 (in °C)	-7
DA	Ambienttemp 4 Vs Water Temp. 4	20 - 65 (in °C)	35
DB	Ambient Temp. 5	-20 - 45 (in °C)	-20
DC	Ambienttemp 5 Vs Water Temp. 5	20 - 65 (in °C)	42

### 3. Usage

Parameter No.	Meaning	Range	Default Value
D1	Heating Curve Function	0(invalid), 1(valid)	1

Heating Curve means let the system adjust the outlet water temperature based on the ambient temperature by continually monitoring and adjusting in opposite direction with the current ambient temperature levels according to a pre-set curve, to optimum comfort levels based on the changing heat demand, insulation levels, etc.

In a way, when it is colder (warmer) outside, house will need a higher (lower) temperature water to keep the same air temperature in the house. Thus we can set a curve for the unit to follow, to let the unit adjust its set temperature for heating operation according to the set curve and actual ambient temperature.

This function can be turned ON/OFF by adjusting the value of this parameter.

Parameter No.	Meaning	Range	Default Value
D2	Room Temp. Effect On Heating Curve	0(invalid), 10 - 60(time period for every adjustment, in minutes)	0

If room temperature sensor is connected, "Set Room Temperature" in "Temperature Parameter" under "Basic Operation" is set, and this "Room Temp. Effect On Heating Curve" is ON, unit will adjust the set water temperature (a set value or calculated value via heating curve), according to the difference between actual room temperature and ideal room temperature.

For example, if current water set temperature calculated according to the heating curve is 35°C:

If actual room temperature is 27°C, while "Set Room Temperature" is set to 22 °C, then the unit will deduct (27 °C-22 °C)=5 °C from water set temperature, which means unit will take 30 °C as the final set temperature.

Parameter No.	Meaning	Range	Default Value
D3	Ambient Temp. 1	-20 - 45 (in °C)	12
D4	Ambienttemp 1 Vs Water Temp. 1	20 - 65 (in °C)	25
D5	Ambient Temp. 2	-20 - 45 (in °C)	7
D6	Ambienttemp 2 Vs Water Temp. 2	20 - 65 (in °C)	28
D7	Ambient Temp. 3	-20 - 45 (in °C)	2
D8	Ambienttemp 3 Vs Water Temp. 3	20 - 65 (in °C)	31
D9	Ambient Temp. 4	-20 - 45 (in °C)	-7
DA	Ambienttemp 4 Vs Water Temp. 4	20 - 65 (in °C)	35
DB	Ambient Temp. 5	-20 - 45 (in °C)	-20
DC	Ambienttemp 5 Vs Water Temp. 5	20 - 65 (in °C)	42

Unit will create a heating curve according to these setting.

Parameter D3, D5, D7, D9 and DB are used to set 5 different ambient temperatures; Parameter D4, D6, D8, DA and DC are used to set 5 corresponding set water temperatures VS the set 5 ambient temperatures. Then a heating curve will be generated automatically.

**Note: Value of parameter D3, D5, D7, D9 and DB should be in negative direction, or say in other way, D3>D5>D7>D9>DB, otherwise the setting of the value may not saved.**

### 3. Usage

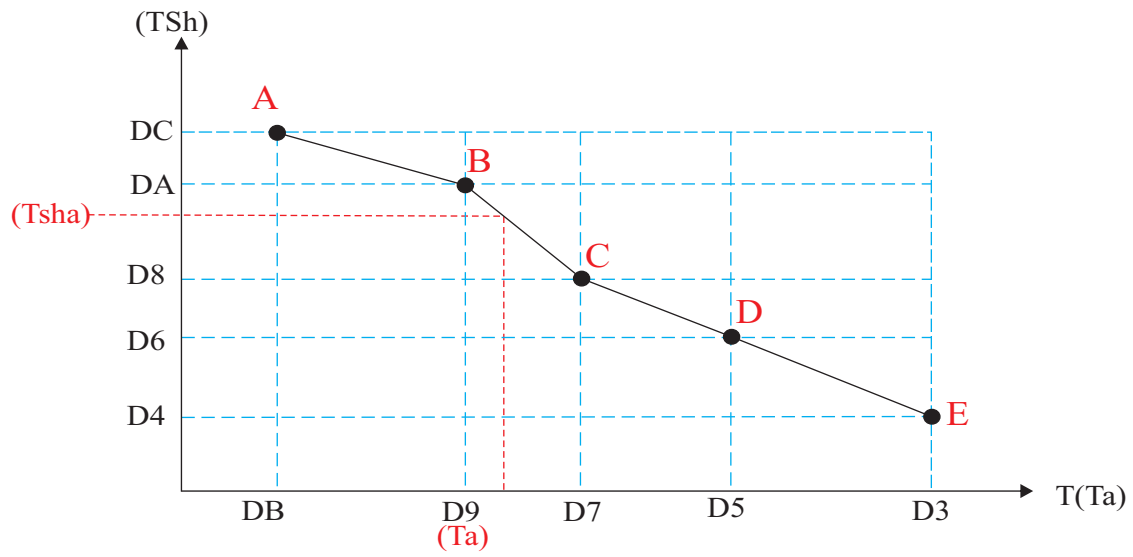

As shown here, actual set water temperature (TSh) is calculated according to actual ambient temperature (Ta), according to this created curve.

# 3. Usage

## 3.4 Advanced Setting

Advanced setting is opened to installer or professional customer. It contains more functions and setting that can maximum the comfort and efficiency of the system. You need to enter the correct password to activate "Advanced Setting":

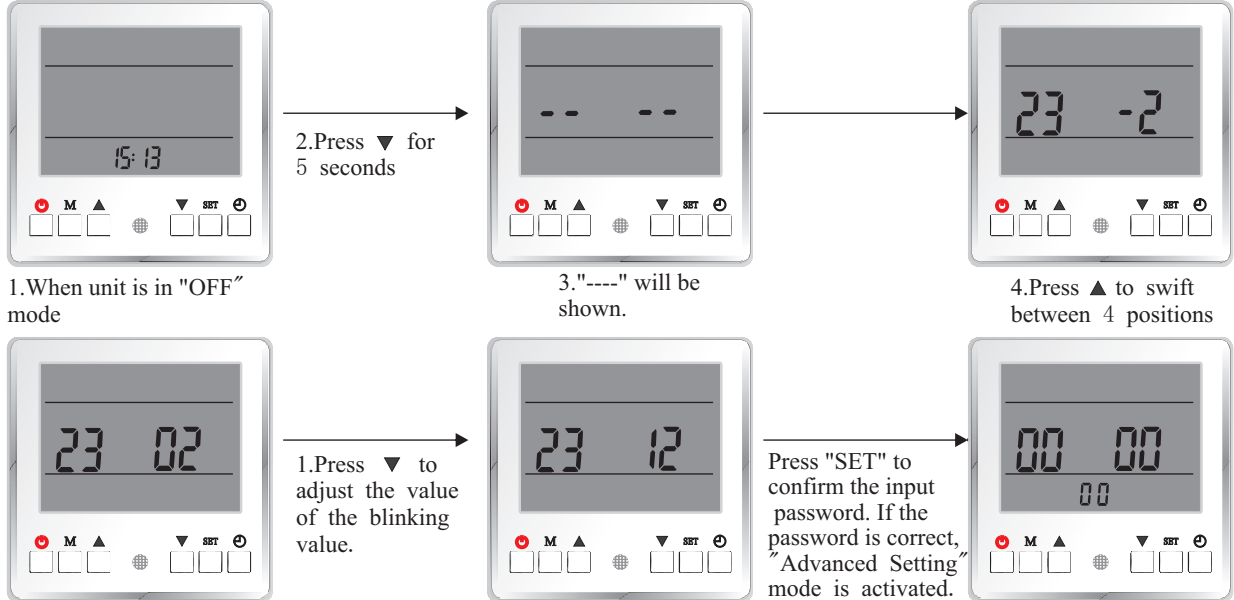

If the password is incorrect, it exits to OFF mode

Operation in Advanced Setting menu:

Complete Advanced Setting menu is divided into 6 groups (Group 0~Group E).

When Advanced Setting menu is activated, press to switch between each group (Group 0, A, B, C, D, E) .

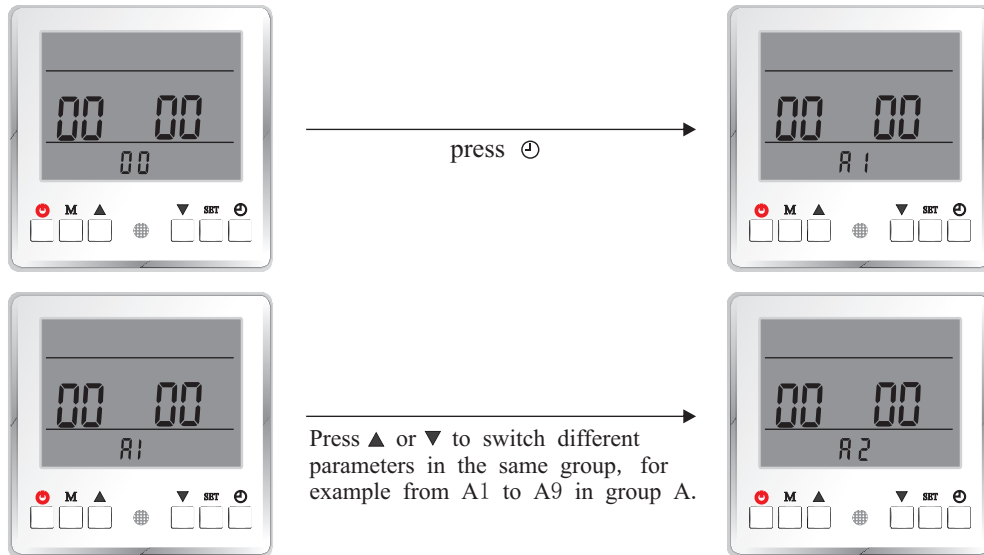

Press "SET" to activate setting of current parameter, with its value blinks.

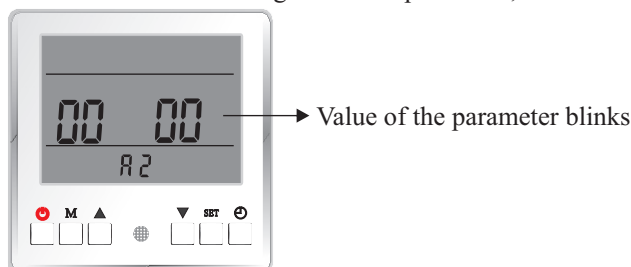

## 3. Usage

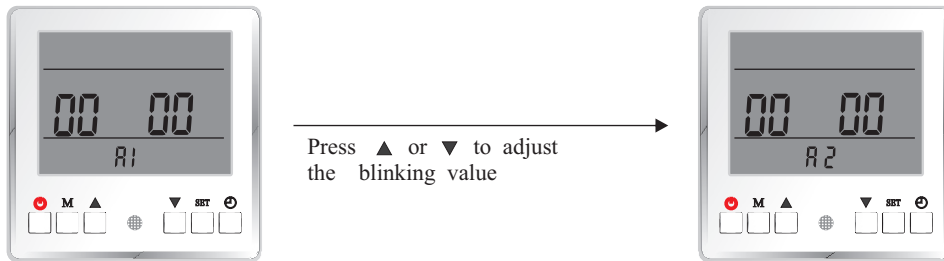

Press "SET" to confirm the setting. If no operation for 6 seconds, it exits to main interface without saving the setting.

### 【System Setting】

#### Group 0

List of parameters

Parameter No.	Meaning	Range	Default Value
0	Indoor Control System Working Mode	0 (normal), 1(testing)	0
1	External ON OFF Switch	0 (invalid), 1(valid)	0
2	Water Flow Switch	0 (invalid), 1 - 60 (checking time, in seconds)	60
3	Heating Buffer Tank	0(no), 1(yes)	0
4	Cooling Buffer Tank	0(no), 1(yes)	0
5	Priority Switch Between Hot Water and Heating Operation	0 (hot Water), 1(heating)	0
6	Refrigerant collecting function	0(off), 1(compressor System 1ON), 2(compressor System 2 ON)	0
7	Lock Function	00 - 99 (in weeks)	00
8	Available working modes	0-DHW-1.Cooling+Heating -2.Cooling+Heating+DHW-3. Heating Only-4.Heating+DHW	2(all functions)
9	Stop/Speed down $\Delta T$ based on set temperature in heating/cooling	2-10	2°C
0a	Max Allowed Duration For Min Compressor Speed	10-60(in minutes)	30 min
Parameter No.	Meaning	Range	Default Value
0	Indoor Control System Working Mode	0 (normal), 1(testing)	0

This function is designed for letting the installer test the output signals of the indoor control system. When this function is activated, indoor control system will activate the relay on the PCB when correspondent port on PCB is short-connected:

Port On PCB	Relay Output	Funtion
ES	EVC	3-way valve (Cooling/Heating Port)
FSW	EVW	3-way valve (Hot Water Port)
HS	SH	Auxiliary Heater
CS	AS	Heating Back-up Heater
IRES	HW	Domestic Hot Water Back-up Heater
ES+FSW	PUMPH	Heating Distribution System Pump
ES+HS	PUMPC	Cooling Distribution System Pump
ES+CS	PO	Unit Circulation Pump
ES+IRES	RHS	Preserved-1
CS+HS	YL	Preserved-2



### 3. Usage

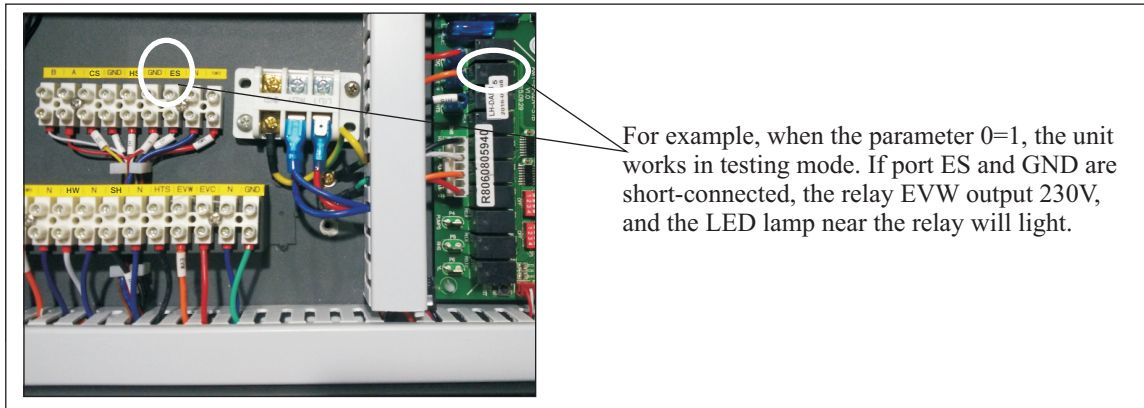

Parameter No.	Meaning	Range	Default Value
1	External ON OFF Switch	0 (invalid), 1(valid)	0

An external Close/Open signal from other control devices can be connected to the ES and GND port shown on the below picture on indoor PCB, to switch ON/OFF the working of complete heat pump unit, if this parameter is set to 1:

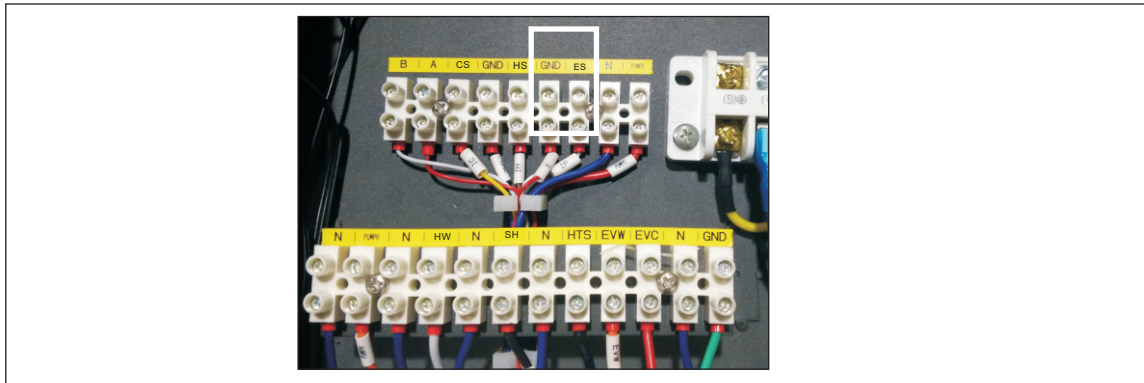

When the input external signal is "close" type, unit works;  
When the input external signal is "open" type, unit stops.

Parameter No.	Meaning	Range	Default Value
2	Water Flow Switch	0 (invalid), 1 - 60 (checking time, in seconds)	60

This parameter is used to set whether the system has a water flow switch or not, and if yes, how many seconds after unit circulation pump starts, unit starts to check the statue of the water flow switch.  
If it is set to "0", unit will not check the statue of the flow switch.  
If it is set to any value except "0", unit starts to check the statue of flow switch after unit circulation pump starts for this set time. If flow switch is in "open" statue at this time, unit will show failure code 00 P7, which means "not enough water flow rate".

**Note:**

**If unit circulation pump is OFF, flow switch should in "open" statue as there should has no flow in the system. If not, unit will take it as the failure of flow switch itself, and give out correspondent failure code 00 Eb.**

Parameter No.	Meaning	Range	Default Value
3	Heating Buffer Tank	0(no), 1(yes)	0

This parameter is used to set whether the system has a buffer tank for heating operation. It is more related to the control of "circulation pump for heating system".  
If there has no buffer tank included in the heating system, "circulation pump for heating system" will work only when the unit works in heating mode. And the circulation pump works for 1 minute after stops for every 6 minutes to read the temperature in the distribution system.  
If there has a buffer tank included in the heating system, "circulation pump for heating system" will work whenever the unit has the demand for heating operation.

### 3. Usage

Parameter No.	Meaning	Range	Default Value
4	Cooling Buffer Tank	0(no), 1(yes)	0

This parameter is used to set whether the system has a buffer tank for cooling operation. It is more related to the control of "circulation pump for cooling system".

If there has no buffer tank included in the cooling system, "circulation pump for cooling system" will work only when the unit works in cooling mode.

If there has a buffer tank included in the cooling system, "circulation pump for cooling system" will work whenever the unit has the demand for cooling operation.

Parameter No.	Meaning	Range	Default Value
5	Priority Switch Between Hot Water and Heating Operation	0 (hot Water), 1(heating)	0

This function is not designed for this model. Please don't set this parameter to 1.

Parameter No.	Meaning	Range	Default Value
6	Refrigerant collecting function	0(off), 1(compressor System 2ON), 2(compressor System 1 ON)	0

This function is used to pump all refrigerant back to outdoor unit in winter time for service purpose. For single compressor system or compressor system 2 of a dual compressor system, set this parameter to 1, to activate the refrigerant collecting function for compressor system 2. For activate the refrigerant collecting function for compressor system 1, set this parameter to 2.

After activated, compressor will start to work to pump the refrigerant back to outdoor unit. After work for 10 minutes, or press  $\odot$  button, this function stops in standby mode. Low ambient temperature protection and low current protection will not be checked under this operation.

Parameter No.	Meaning	Range	Default Value
7	Lock Function	00 - 99 (in weeks)	00

Attention: The usage of this function must comply with the local law or regulation system. Factory will not take any legal responsibility caused by the abuse of this function!!

This parameter is counted in weeks. Unit will be locked after set time is over, and can only be released by putting in the preset password.

How to set the pre-set password

Pre-set the password: In standby mode, Press  $\blacktriangle$  and "SET" at the same time for 5 seconds, "0000" will be shown on the screen. Press "SET" again to activate the setting of password. Press "UP" to swift between 4 positions, and press  $\blacktriangledown$  to adjust the value of the blinking value.

Parameter No.	Meaning	Range	Default Value
8	Available working modes	0-DHW-1.Cooling+Heating 2.Cooling+Heating+DHW-3. Heating Only-4.Heating+DHW	2(all functions)

0.If unit available working mode is set to 0, which means only DHW function can be activated, TH/TC/TR sensor can be disconnected.

1.If unit available working mode is set to 1, which means only Heating or Cooling or Heating+Cooling function can be activated, TW sensor can be disconnected.

2.If unit available working mode is set to 2, which means all functions are enable, and all sensors should be connected.

3.If unit available working mode is set to 3, which means only Heating function can be activated, TW and TC sensor can be disconnected.

4.If unit available working mode is set to 4, which means only DHW or Heating or Heating+DHW function can be activated, TC can be disconnected.

## 3. Usage

Parameter No.	Meaning	Range	Default Value
9	Stop/Speed down $\Delta T$ based on set temperature in heating/cooling	2-10	2
0a	Max Allowed Duration For Min Compressor Speed	10-60(in minutes)	30

Stop/Speed down  $\Delta T$  based on set temperature in heating/cooling:

Stop  $\Delta T$  based on set temperature in heating/cooling means after the unit heat/cool the water (or air, if in room temperature control mode) above/below set temperature over the set delta T here, unit stops.

Speed down  $\Delta T$  based on set temperature in heating/cooling means after the unit heat/cool the water (or air, if in room temperature control mode) above/below set temperature below the set delta T. There, unit starts to reduce its speed.

Max Allowed Duration For Min Compressor Speed:

When unit output is higher than demand, compressor speed will be reduced. If compressor has continuously work in minimum compressor speed for over time set via "Max Allowed Duration For Min Compressor Speed", unit stops.

**【NOTE】** Parameter 9 and Parameter 0a are used by the installer only to limit the function of the unit. By setting the parameter to a certain value, user can only select the limited working mode(s).

### 【Water Pump Setting】

#### Group A

List of parameters

Parameter No.	Meaning	Range	Default Value
A1	Unit Circulation Pump Control Type	0 (controlled by unit), 1 -15 (ON for set time, in minutes), 16 (always ON)	0
A2	Heating Circulation Pump Control Type	0 (controlled by unit), 1 -15 (ON for set time, in minutes), 16 (always ON)	0
A3	Cooling Circulation Pump Control Type	0 (controlled by unit), 1 -15 (ON for set time, in minutes), 16 (always ON)	0

### 3. Usage

Parameter No.	Meaning	Range	Default Value
A4	Heating Circulation Pump Start Temperature	20 - 50 (in °C)	20
A5	Heating Circulation Pump Stop Temperature	18 - 50 (in °C)	18
A6	Cooling Circulation Pump Start Temperature	5 - 20 (in °C)	18
A7	Cooling Circulation Pump Stop Temperature	5 - 20 (in °C)	20
A8	Unit Motorized 3-way valve Switching Time	0 (Always ON), 1 - 600(With power for the set time, in seconds)	120
A9	Heating Operation Motorized 3-way valve Direction	0 (Same as Hot Water Operation), 1(Same as Cooling Operation)	1

Parameter No.	Meaning	Range	Default Value
A1	Unit Circulation Pump Control Type	0 (controlled by unit), 1 - 15 (ON for set time, in minutes), 16 (always ON)	0
A2	Heating Circulation Pump Control Type	0 (controlled by unit), 1 - 15 (ON for set time, in minutes), 16 (always ON)	0
A3	Cooling Circulation Pump Control Type	0 (controlled by unit), 1 - 15 (ON for set time, in minutes), 16 (always ON)	0

These three parameters are designed for manual turn ON the pump during installation or service work. When the parameter is set to any value other than 0, the correspondent pump will start to work immediately, and stop automatically after set time is finished.

This can be used to check the statue of the circulation pump, or circulate the water for air purging purpose before unit starts.

Parameter No.	Meaning	Range	Default Value
A4	Heating Circulation Pump Start Temperature	20 - 50 (in °C)	20
A5	Heating Circulation Pump Stop Temperature	18 - 50 (in °C)	18
A6	Cooling Circulation Pump Start Temperature	5 - 20 (in °C)	18
A7	Cooling Circulation Pump Stop Temperature	5 - 20 (in °C)	20

For heating operation, if water temperature is too low, it has no meaning to circulate this "cold" water into house heating distribution system.

Thus when heating circulation pump is OFF, it will only start to work when water temperature is higher than set "Heating Circulation Pump Start Temperature"; When heating circulation pump is working, it will stop if water temperature is lower than set "Heating Circulation Pump Stop Temperature".

For cooling operation, if water temperature is too high, it has no meaning to circulate this "hot" water into house cooling distribution system.

Thus when cooling circulation pump is OFF, it will only start to work when water temperature is low than set "Cooling Circulation Pump Start Temperature"; When cooling circulation pump is working, it will stop if water temperature is higher than set "Cooling Circulation Pump Stop Temperature".

## 3. Usage

Parameter No.	Meaning	Range	Default Value
B4	Anti-freezing Function	0(invalid), 1(valid)	1
B5	Anti-freezing Starting Ambient Temperature--Primary	5 - 10 (in °C)	5
B6	Anti-freezing Starting Ambient Temperature--Secondary	0 - 4 (in °C)	2
B7	Anti-freezing Ending Ambient Temperature--Secondary	0 - 10 (in °C)	5
B8	Anti-freezing Starting Water Temperature--Secondary	0 - 10 (in °C)	2
B9	Anti-freezing Ending Water Temperature--Secondary	5 - 20 (in °C)	15

Anti-freezing function can be activated, to protect the unit from damage caused by water freezing inside the unit.

**Note: If unit is out of power, or water circuit is blocked, anti-freezing protection will not function properly. Anti-freezing protection doesn't mean the anti-freezing protection for all water system in the house. Please apply other necessary anti-freezing protections in your house, to protect the house from damage caused by freezing.**

When unit is OFF and anti-freezing protection is valid, if ambient temperature is lower than the "Anti-freezing Starting Ambient Temperature--Primary", unit activate primary anti-freezing protection. Circulation pump will be forced to work occasionally.

When unit is OFF and anti-freezing protection is valid, if ambient temperature is lower than "Anti-freezing Starting Ambient Temperature--Secondary", if water outlet temperature is lower than "Anti-freezing Starting Water Temperature--Secondary", compressor will be forced to work, until water outlet temperature is higher than "Anti-freezing Ending Water Temperature--Secondary", or ambient temperature is higher than "Anti-freezing Ending Ambient Temperature--Secondary".

### 【Backup Heating】

#### Group C

List of parameters

Parameter No.	Meaning	Range	Default Value
C1	Manual ON/OFF of Heater in Hot Water Mode	0(invalid), 1(valid)	0
C2	Backup Heating Source For Hot Water Mode	0(no), 1(yes)	0
C3	Priority Of Backup Heating Sources For Hot Water Mode (Compared With Unit Auxiliary Heater)	0(lower), 1(higher)	0
C4	Temperature Increase Checking Duration in Hot Water Mode	1 - 20(in minutes)	40
C5	Maximum Allowable Set Water Temperature in Heating Mode	0 (not exceeds compressor maximum allowable water temperature), 40 - 65 (maximum allowable set water temperature in heating mode)	42
C6	Manual ON/OFF of Heater in Heating Mode	0(invalid), 1(valid)	0
C7	Backup Heating Source For Heating Mode	0(no), 1(yes)	1
C8	Priority Of Backup Heating Sources For Heating Mode (Compared With Unit Auxiliary Heater)	0(lower), 1(higher)	1
C9	Accumulated Value between operation time VS set temp. for Heating Mode	0 - 600	45

### 3. Usage

Parameter No.	Meaning	Range	Default Value
A8	Unit Motorized 3-way valve Switching Time	0 (Always ON), 1 - 600(With power for the set time, in seconds)	120
A9	Heating Operation Motorized 3-way valve Direction	0 (Same as Hot Water Operation), 1(Same as Cooling Operation)	1

Parameter A8 is used to set the type of the motorized 3-way valve used to switch the direction of water flow in different working modes. If it is set to 0, it means two directions of the valve is controlled by "with" or "without" power. If it is set to any value other than 0, it means the valve takes this time to switch from one direction fully to the other direction.

In some special application, heating and hot water may use the same water circuit. In this way, one can set parameter A9 to 0, so unit has one water direction for both hot water and heating, and one direction for cooling only.

#### 【Anti-legionella and Anti-freezing】

##### Group B

Parameter No.	Meaning	Range	Default Value
B1	Anti-Legionella Set Temperature	60 - 75 (in °C)	60
B2	Anti-Legionella Duration	10 - 60 (in minutes)	30
B3	Anti-Legionella Maximum Allowable Working Duration	10 - 240 (in minutes)	120
B4	Anti-freezing Function	0(invalid), 1(valid)	1
B5	Anti-freezing Starting Ambient Temperature--Primary	5 - 10 (in °C)	5
B6	Anti-freezing Starting Ambient Temperature--Secondary	0 - 4 (in °C)	2
B7	Anti-freezing Ending Ambient Temperature--Secondary	0 - 10 (in °C)	5
B8	Anti-freezing Starting Water Temperature--Secondary	0 - 10 (in °C)	2
B9	Anti-freezing Ending Water Temperature--Secondary	5 - 20 (in °C)	15

Parameter No.	Meaning	Range	Default Value
B1	Anti-Legionella Set Temperature	60 - 75 (in °C)	60
B2	Anti-Legionella Duration	10 - 60 (in minutes)	30
B3	Anti-Legionella Maximum Allowable Working Duration	10 - 240 (in minutes)	120

If user uses sanitary hot water directly out from the hot water tank, for healthy purpose, it' s requested to heat up the water inside the tank over 60°C (please refers to local regulations) for water sanitization once a week.

**Note: ON/OFF of this function can be set in "Basic Operation" level via parameter setting.**

When this function is ON, if in 7\*24 hours time period, unit has not reached the set water temperature for "anti-legionella function" (set in Advanced Menu) even once, then unit will activate anti-legionella operation at "Anti--legionella function starting time".

Heat Pump will heat the water up to 58°C, together with Auxiliary Heater or Hot Water Back-up Heater to get the set "Anti-Legionella Set Temperature", and keep this temperature for "Anti-Legionella Duration" time, Anti-Legionella operation is finished successfully.

If after working over "Anti-Legionella Maximum Allowable Working Duration", Anti-Legionella operation still has not finished successfully, unit will be forced to end Anti-Legionella operation.

### 3. Usage

Parameter No.	Meaning	Range	Default Value
C1	Manual ON/OFF of Heater in Hot Water Mode	0(invalid), 1(valid)	0

If heat pump unit meets a failure, extra heating source (unit "Auxiliary Heater" or "Backup Heating Source For Hot Water Mode" can be manually switched ON for heating up the shower water by set "Manual ON/OFF of Heater in Hot Water Mode" to ON.

Parameter No.	Meaning	Range	Default Value
C2	Backup Heating Source For Hot Water Mode	0(no), 1(yes)	0
C3	Priority Of Backup Heating Sources For Hot Water Mode (Compared With Unit Auxiliary Heater)	0(lower), 1(higher)	0
C4	Temperature Increasement Checking Duration in Hot Water Mode	1 - 20(in minutes)	40

If there has a "Backup Heating Source For Hot Water Mode" connected, it can be put under the control of the unit by set "Backup Heating Source For Hot Water Mode" to ON.

And, as both "Backup Heating Sources For Hot Water Mode" and unit "Auxiliary Heater" can both be used as extal heating source for hot water mode, the "Priority Of Backup Heating Sources For Hot Water Mode (Compared With Unit Auxiliary Heater)" can be set, to choose "Backup Heating Sources For Hot Water Mode" or unit "Auxiliary Heater" is preferred to be activated first.

When:

Hot Water Temperature increasement in "Temperature Increasement Checking Duration in Hot Water Mode" is not enough and actual water temperature is not over 58°C, unit will activate the higher priority extra heating source first. If increasement is still not enough, unit will activate the lower priority extra heating source also.

If set and actual hot water temperature is over 58°C, unit will activate the higher priority extra heating source.

In this case, if "Backup Heating Source For Hot Water Mode" has higher priority, as it doesn't need to use the unit water circulation, heat pump unit will turn to heating or cooling operation to maximum the usage of heat pump.

Parameter No.	Meaning	Range	Default Value
C5	Maximum Allowable Set Water Temperature in Heating Mode	0 (not exceeds compressor maximum allowable water temperature), 40 - 65 (maximum allowable set water temperature in heating mode)	42

In heating mode, compressor can only work till maximum 58°C water temperature. But in some real cold days, this temperature may still not enough for keep heating up the house, then a higher allowable temperature can be set here, to the unit can use extra heating source (unit Auxiliary Heater or Back Heating Source For Heating Mode) to ensure the comfort of heating operation.

**Note: This function should only be used if water temperature really need to be over 58°C to heat up the house. If not, it will waste energy as most of the heating may carried by extra heating source.**

If floor heating is used as distribution system, please be sure the water flow into floor heating system not exceed the maximum allowable water temperature for floor heating system, otherwise it may get damaged. It can be controlled by set this parameter to a safety value, or add safety regulations at inlet of a floor heating system.

Parameter No.	Meaning	Range	Default Value
C6	Manual ON/OFF of Heater in Heating Mode	0(invalid), 1(valid)	0

If heat pump unit meets a failure, extra heating source (unit "Auxiliary Heater" or "Backup Heating Source For Heating Mode" can be manually switched ON for heating up the house by set "Manual ON/OFF of Heater in Heating Mode" to ON.

### 3. Usage

Parameter No.	Meaning	Range	Default Value
C7	Backup Heating Source For Heating Mode	0(no), 1(yes)	1
C8	Priority Of Backup Heating Sources For Heating Mode (Compared With Unit Auxiliary Heater)	0(lower), 1(higher)	1
C9	Accumulated Value between operation time VS set temp. for Heating Mode	0 - 600	45

If there has a "Backup Heating Source For Heating Mode" connected, it can be put under the control of the unit by set "Backup Heating Source For Heating Mode" to ON.

And, as both "Backup Heating Sources For Heating Mode" and unit "Auxiliary Heater" can both be used as extal heating source for heating mode, the "Priority Of Backup Heating Sources For Heating Mode (Compared With Unit Auxiliary Heater)" can be set, to choose "Backup Heating Sources For Heating Mode" or unit "Auxiliary Heater" is preferred to be activated first.

When:

Unit capacity is not enough ("Accumulated Value between operation time VS set temp. for Heating Mode" over the set value), or actual and water temperature is over 55°C, unit will activate the higher priority extra heating source first. If totally heating capacity is still not enough ("Accumulated Value between operation time VS set temp. for Heating Mode" over the set value again), unit will activate the lower priority extra heating source also.

#### 【Heating Curve】

##### Group D

Please check the introduction on page 53.

#### 【Heat Recovery and Shifting Priority】

##### Group E

List of parameters:

Parameter No.	Meaning	Range	Default Value
E1	Heat Recovery Function	0(invalid), 1(valid)	0
E2	Hot Water Restart Based On $\Delta T$ in Heat Recovery Operation	5 - 10 (in°C)	5
E3	Hot Water Stop Based On $\Delta T$ in Heat Recovery Operation	1 - 10 (in°C)	5
E4	Allowable Temp Drift In Heating in Shifting Priority Operation	3 - 20 (in°C)	5
E5	Heating Max. Working Hours in Shifting Priority Operation	20 - 180 (in minutes)	30
E6	Hot Water Min. Working Hours in Shifting Priority Operation	20 - 180 (in minutes)	50
E7	Working of Extra Heating Source for Hot Water in Shifting Priority Operation	0 (no), 1(yes)	0

Parameter No.	Meaning	Range	Default Value
E1	Heat Recovery Function	0(invalid), 1(valid)	0
E2	Hot Water Restart Based On $\Delta T$ in Heat Recovery Operation	5 - 10 (in°C)	5
E3	Hot Water Stop Based On $\Delta T$ in Heat Recovery Operation	1 - 10 (in°C)	5



### 3. Usage

These parameters are valid only for the units with heat recovery function. For the unit without this function, "Heat Recovery Function" should always set to 1 (invalid).

If it is set to ON, unit will try to heat up the hot water by recover the wasted heat in heating and cooling operation. It will turn ON heat recovery circuit if actual hot water temperature is "Hot Water Restart Based On ΔT in Heat Recovery Operation" lower than set hot water temperature, and stop after it heat the hot water to "Hot Water Stop Based On ΔT in Heat Recovery Operation" over set hot water temperature.

If 1 hour before "Normal Shower Time" set in "Time and Timer Setting" under Basic Operation , hot water temperature has still not reached the set value, unit will activate standard hot water operation to ensure you can enjoy enough hot shower water at/after this time.

Parameter No.	Meaning	Range	Default Value
E4	Allowable Temp Drift In Heating in Shifting Priority Operation	3 - 20 (in °C)	5
E5	Heating Max. Working Hours in Shifting Priority Operation	20 - 180 (in minutes)	30
E6	Hot Water Min. Working Hours in Shifting Priority Operation	20 - 180 (in minutes)	50

If "Shifting Priority" function is turned ON in "Temperature Parameter" setting under Basic Operation, when actual ambient temperature is lower than "Shifting Priority" setting, Shifting Priority function will be activated.

Unit will firstly work in Hot Water Mode. If it gets the set temperature for hot water, or it has been working in Hot Water Mode over "Hot Water Min. Working Hours in Shifting Priority Operation", and temperature for heating has dropped over "Allowable Temp Drift In Heating in Shifting Priority Operation" based on set heating temperature, unit switch to heating. After switch to heating operation, if it gets the set temperature for hot water, or it has been working in heating operation for over "Heating Max. Working Hours in Shifting Priority Operation", unit switch back to hot water. This process will repeat continuously

Working Procedure of Shifting Priority Function:

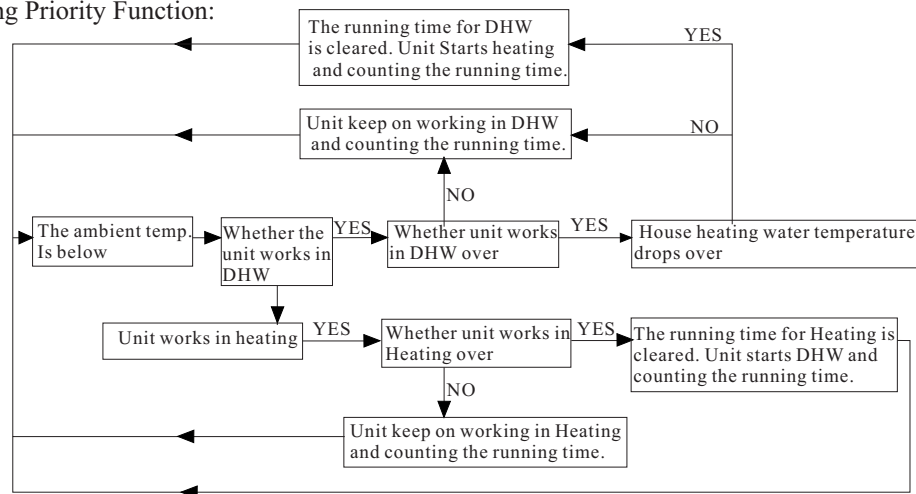

Parameter No.	Meaning	Range	Default Value
E7	Working of Extra Heating Source for Hot Water in Shifting Priority Operation	0 (no), 1(yes)	0

In shifting priority operation, when the unit switches to heating , this function can be activated to turn on extra heating source for hot water, and help to reach the set temperature for hot water.

If Parameter E7 is set as 1, the extra heating source for hot water will turn on when unit switches to heating in shifting priority operation.

If Parameter E7 is set as 0, the extra heating source for hot water will turn off when unit switches to heating in shifting priority operation.

**Note:** The extra heating source for hot water should be connected to the port HTW on the indoor PCB to activate the function. For AWT model, this function is invalid, because 1.5KW electric heater inside the water tank is controlled by digital thermostat directly, and there is no other heating source connected to HTW port.

## 3. Usage

### ■ 3.5 Failure code

When unit is in ON/OFF mode and has some failure, which part has this failure and the failure code will be shown as follows:

00: indoor unit

01: compressor system 1

02: compressor system 2

03: Wired controller

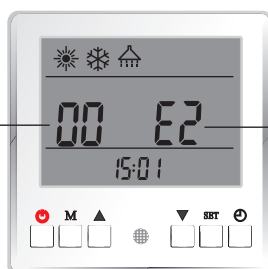

Failure code or protection code

# 3. Usage

## 3.6 Error code

### Outdoor Unit Failure Codes.

**01 or 02 stands for different compressor systems. For sigle compressor system, it indicates the failure of outdoor unit no matter 01 or 02 is shown.**

Type	Code	Failure	Unit worki ng statue	Possible Reasons And Solutions
Protection	01(02) P1	Main line current protection	Comprssor stops	Input current too high or too low, or system works in over-load condition. Unit recovers automatically after 5 minutes when it happened the first time. If same failure happened 3 times in a certain period of time, unit stops until repowered. Check unit input current. Check whether fan motor and water pump is working OK; whether condensor is blocked; whether water temperature too high, and whether water inlet&outlet temperature has too big difference (should no bigger than 8°C)
	01(02) P2	Compressor phase current protection	Comprssor stops	Compressor input current too high or too low, or system works in over-load condition. Check compressor input current. Check whether fan motor and water pump is working OK; whether condensor is blocked; whether water temperature too high, and whether water inlet& outlet temperature has too big difference (should no bigger than 8°C)
	01(02) P3	IPM module protection	Comprssor stops	Compressor drive failure. Check whether cable is broken or loosen. Check whether compressor driver PCB or compressor is broken.
	01(02) P4	Compressor oil return protection	Compressor speed up	If unit has been continuously working in low speed for certain period of time, unit starts this protection to suck compressor oil back into compressor. This is a normal protection and doesn't need any treatment.
	01(02) P5	Compressor shut down due to high pressure switch (or low pressure switch, if have) open caused by abnormal high/low pressure	Comprssor stops	If system pressure is too high or too low, it activates this protection. Unit recovers automatically after 5 minutes when it happened the first time. If same failure happened 3 times in a certain period of time, unit stops until repowered (with 01(02) F7 failure code also shown on the display). Check whether fan motor and water pump is working OK; whether condensor is blocked; whether water temperature too high, and whether water inlet&outlet temperature has too big difference (should no bigger than 8°C)
	01(02) P6	Compressor speed down due to abnormal high pressure detected by condensing pressure sensor	Comprssor stops	This protection happens when system pressure is higher than the set compressor speed-down pressure point. If after slow down the compressor speed but pressure still higher than the protection point, compressor stops. Check whether water temperature set value is too high; whether system water flow rate too small; whether EEV works normally; whether air circulates fluently in cooling mode; whether water inlet&outlet temperature has too big difference (should no bigger than 8°C). If this failure happens over three times in a certain period of time, it will cause 01(02) FC failure.
	01(02) P7	Compressor preheating	Standard function, doesn't need any treatment.	This is a normal protection and doesn't need any treatment. When compressor did not work for long time and ambient temperature is low (below -5°C), compressor crankcase heater work for 30 mins and stops.
	01(02) P8	Compressor discharge temp. too high protection	Comprssor stops	Check whether water temperature set value is too high, especially when ambient temperature is low; whether water flow rate too small; whether system is lacking of enough refrigerant.

### 3. Usage

#### Outdoor Unit Failure Codes.

Type	Code	Failure	Unit working statue	Possible Reasons And Solutions
Protection	01(02) P9	Outdoor evaporator coil temp. sensor protection	Comprssor stops	This is a protection caused by outdoor coil temperature too high. Check whether air circulates fluently in outdoor unit, air flow is too small, ambient temperature is too high. If the same protection happens over 3 times in certain period of time, unit can only be reset by repower.
	01(02) Pa	AC over high/low voltage protection	Comprssor stops	Unit input voltage too high or too low. Check the voltage of unit power supply if it's higher than 264V or lower than 180V.
	01(02) Pb	Compressor shut down due to too high/low ambient temperature	Comprssor stops	Ambient temperature is too high or too low for unit to work.
	01(02) Pc	Compressor speed limit due to too high/low ambient temperature	Compressor speed down	Ambient temperature is too high or too low for unit to work in full speed. This is a normal protection and doesn't need any treatment.
	01(02) Pd	Preserved	Preserved	Preserved
	01(02) PE	Compressor speed down due to abnormal low pressure detected by evaporating pressure sensor	Comprssor stops	This protection happens when system evaporating pressure is higher than the set compressor speed-down pressure point. If after slow down the compressor speed but pressure still lower than the protection point, compressor stops. Check whether water temperature set value is too high; whether system water flow rate too small; whether EEV works normally; whether air circulates fluently in cooling mode or ambient temperature too high in heating mode; If same protection happens over 3 times in certain period of time, unit shows 01 (02) Fb.
Failure	01(02) F1	Outdoor ambient temp. sensor failure	Comprssor stops	Check whether ambient temperature sensor is open, short-circuit or value drifts too much. Replace it if necessary. If unit gives this failure code only when compressor is working, please check whether the ambient temperature sensor and coil temperature sensor is mixed.
	01(02) F2	Outdoor evaporator coil temp. sensor failure	Comprssor stops	Check whether outdoor coil temperature sensor is open, short-circuit or value drifts too much. Replace it if necessary.
	01(02) F3	Compressor discharge temp. sensor failure	Comprssor stops	Check whether compressor discharge temperature sensor is open, short-circuit or value drifts too much. Replace it if necessary.
	01(02) F4	Outdoor Suction temp. sensor failure	Comprssor stops	Check whether outdoor suction temperature sensor is open, short-circuit or value drifts too much. Replace it if necessary.
	01(02) F5	Evaporating pressure sensor failure	Comprssor stops	Check whether evaporating temperature sensor is open, short-circuit or broken. Replace it if necessary. If unit has no low pressure sensor, then it should be a wrong Eeprom setting on the power PCB.
	01(02) F6	Condensing pressure sensor failure	Comprssor stops	Check whether condensing temperature sensor is open, short-circuit or broken. Replace it if necessary. If unit has no high pressure sensor, then it should be a wrong Eeprom setting on the power PCB.
	01(02) F7	High pressure switch failure (High/low pressure switch failure, if system has low pressure switch)	Comprssor stops	1. If pressure switch is in open position when unit is in standby statue, or 2 minutes after compressor stops, unit gives this failure. Check whether high or low pressure switch is broken or not well connected. 2. If system gives 01(02) P5 3 times in a certain period of time, unit stops until repowered (with 01(02) F7 failure code also shown on the display). Check whether fan motor and water pump is working OK; whether condensor is blocked; whether water temperature too high, and whether water inlet&outlet temperature has too big difference (should no bigger than 8℃).

### 3. Usage

#### Outdoor Unit Failure Codes.

Type	Code	Failure	Unit working statue	Possible Reasons And Solutions
Failure	01(02) F8	Water flow switch failure	Comprssor stops	Preserved for monoblock unit only. Please check the statue of water flow switch.
	01(02) F9	DC fan failure (FAN2)	Comprssor speed down (dual fan system) or stops (single fan system) When both FAN 1 and FAN2 failed to work in dual fan system, compressor stops.	Speed of DC fan (FAN 2) can't reach the required value or no feedback signal. Please check whether the PCB or fan motor is broken. Or Check if fan motor connect to a wrong port in PCB. Check whether the fan motor is AC fan motor instead of DC fan motor, if so, unit has a wrong Eeprom setting. Check whether the system is a single fan system, but gives this failure code and compressor works in a limited speed, if so, unit has a wrong Eeprom setting.
	01(02) Fa	DC fan failure (FAN1)	Comprssor speed down (dual fan system).When both FAN 1 and FAN2 failed to work in dual fan system, compressor stops.	Speed of DC fan (FAN1) can't reach the required value or no feedback signal. Please check whether the PCB or fan motor is broken. Or Check if fan motor connect to a wrong port in PCB. Check whether the fan motor is AC fan motor instead of DC fan motor, if so, unit has a wrong Eeprom setting. If the system is a single fan system, but gives this failure code and compressor works in a limited speed, if so, unit has a wrong Eeprom setting.
	01(02) Fb	System evaporating pressure too low/system evaporating pressure sensor failure	Comprssor stops	If system evaporating pressure too high protection, 01(02) PE detected by evaporating pressure sensor, happened 3 times in a certain period of time, or evaporating sensor is not well connected or failed to work, it gives this failure code and unit can't be restarted until repowered. Check whether system has not enough refrigerant or leakage inside(more likely it is not enough refrigerant that caused this abnormal evaporating pressure); whether fan motor and water pump is working OK; whether condensor is blocked; whether EEV whether EEV works normally; whether water temperature too high in heating/hot water mode, and whether water inlet&outlet temperature has too big difference in cooling(should no bigger than 8°C).
	01(02) Fc	System condensing pressure too high	Comprssor stops	If system too high pressure protection, 01(02)P6, detected by condensing pressure sensor happened 3 times in a certain period of time, it gives this failure code and unit can't be restarted until repowered. Check whether water flow rate is not enough (more likely it is not enough water flow rate that caused system build up too high pressure); whether fan motor and water pump is working OK; whether condensor is blocked; whether EEV works normally; whether water temperature too high, and whether water inlet&outlet temperature has too big difference (should no bigger than 8°C)
System failure	01(02) E1	Communication between operation panel and indoor PCB or outdoor PCB failure	Comprssor stops	Communication failure between operation panel and the indoor or outdoor PCB. Check the cable connection in between. Check whether the last three switches on outdoor power PCB are set to 001; whether last three switches on indoor PCB are set to 001. Check if indoor or outdoor PCB is broken. Indoor PCB is master, wired controller and outdoor PCB are slaver. Unit recovers when communication recovers.

## 3. Usage

### Outdoor Unit Failure Codes.

Type	Code	Failure	Unit working statue	Possible Reasons And Solutions
System failure	01(02) E2	Outdoor power PCB and driver PCB communication failure	Comprssor stops	Check the communication cable between outdoor power PCB and driver PCB. Check whether outdoor power PCB or driver PCB is broken. Replace it.
	01(02) E3	Compressor phase current failure (open/short circuit)	Comprssor stops	Check whether the power cable to compressor is broken or short-circuit.
	01(02) E4	Compressor phase current overload (over current)	Comprssor stops	Check if outdoor drive PCB is broken, replace it, Check if the compressor is broken, replace it, Check if the wiring to compressor is not connected well..
	01(02) E5	Compressor driver failure	Comprssor stops	Check whether compressor drive PCB is broken, or cable to compressor is wrong connected, or compressor is broken.
	01(02) E6	Module VDC over high/low voltage failure	Comprssor stops	Input voltage too high or too low Check if outdoor drive PCB is broken, replace it.
	01(02) E7	AC current failure	Comprssor stops	Check the current to outdoor unit, and compare it with the unit current shown on the operation panel. If the difference is not big, check whether the system has enough refrigerant (more likely it is not enough refrigerant that caused this abnormal low current). If the difference is big, outdoor power PCB is broken. Please replace it with a new one; Detect if the current detecting wiring pass through current transformer.
	01(02) E8	EEPROM failure	Comprssor stops	Please contact the distributor for the correct Eeprom setting, and have the outdoor PCB Eeprom setting updated with the correct one.

# 3. Usage

## Indoor Controller Failure Codes

Type	Code	Failure	Unit working statue	Possible Reasons And Solutions
Failure	00 E1	Ambient temp. sensor failure	1.Cooling operation is limited. 2.Cooling and heating auto-switch is not available. 3.Unit will use compressor discharge temperature as reference for anti-freezing protection. 4. Bivalent function is not available.	Check whether ambient temperature sensor is open, short-circuit or value drifts too much. Replace it if necessary. For a dual compressor system, ambient temperature sensor for both compressor systems need to be replaced as this failure happens only when both sensors can't give the correct temperature reading.
	00 E2	Sanitary hot water temp. sensor failure	Sanitary hot water mode is not available.	Check whether sanitary hot water temperature sensor is open, short-circuit or value drifts too much. Replace it if necessary.
	00 E3	Heating water temp. sensor failure	Heating mode is not available.	Check whether heating water temperature sensor is open, short-circuit or value drifts too much. Replace it if necessary.
	00 E4	Cooling water temp. sensor failure	Cooling mode is not available.	Check whether cooling water temperature sensor is open, short-circuit or value drifts too much. Replace it if necessary.
	00 E5	Unit water outlet temp. sensor failure	Unit stops	Check whether unit water outlet temperature sensor is open, short-circuit or value drifts too much. Replace it if necessary.
	00 E6	Unit water inlet temp. sensor failure	Unit stops	Check whether unit water inlet temperature sensor is open, short-circuit or value drifts too much. Replace it if necessary.
	00 E7	System 2 indoor coil temp. sensor failure	System 2 stops	Check whether indoor coil temperature sensor of system 2 is open, short-circuit or value drifts too much. Replace it if necessary.
	00 E8	System 1 indoor coil temp. sensor failure	System 1 stops	For dual compressor system: check whether indoor coil temperature sensor of system 1 is open, short-circuit or value drifts too much. Replace it if necessary. For single compressor system: check dip-switch number DIP2-1. It should be in OFF position stands for single compressor system.
	00 E9	Room temp. sensor failure	1.Room temperature control mode can't be activated. 2.Room temperature compensate function can't be activated.	Check whether room temperature sensor is open, short-circuit or value drifts too much. Replace it if necessary.
	00 Ea	Indoor EEPROM failure	Unit keep on working	Reset EEPROM setting. If still not OK, replace the indoor PCB. Reset EEPROM: Press "reset" button on indoor PCB when indoor unit is powered, unit will reset EEPROM automatically. After done, LED light for indicating the statue of relay "YL" will be powered. Repower the unit. After EEPROM reset done, all previous setting done by the operation panel is erased. Please set all functions again.
00 Eb	Water flow switch failure	Compressor stops	If water flow switch is in "CLOSE" type when water pump is not working, unit gives this failure code. Check whether there has a external circulation pump circulates the water through heat pump unit when unit circulation pump is OFF; check wheter water flow switch is broken so it is always in "CLOSE" mode.	

### 3. Usage

Type	Code	Failure	Unit working status	Possible Reasons And Solutions
Failure	00 Ec	Too small water flow rate failure	Compressor stops	If system water flow rate too small protection, 00P7, happens over 3 times in certain period of time, unit gives this failure code and can only be reset by repower the unit. Check the water system, especially the filter; check the working status of water pump.
	00 P1	System 1 communication protection	System 1 stops	Communication data lost too much. Check whether communication cable is correctly connected; check whether communication cable is longer than 30M; whether there has a source of the disturbance nearby the unit. Unit recovers when communication recovers. 2.For single compressor system, please check whether number 6, 7, and 8 the dip-switch JNP401 setting on outdoor PCB are set to "0". 3.For dual compressor system, if only system 1 has this failure and the dip-switch setting is OK, then please try with a new outdoor power PCB.
	00 P2	System 2 communication protection	System 2 stops	Communication data lost too much. Check whether communication cable is correctly connected; check whether communication cable is longer than 30M; whether there has a source of the disturbance nearby the unit. Unit recovers when communication recovers. 2.For single compressor system, please check whether number 6, 7, and 8 the dip-switch JNP401 setting on outdoor PCB are set to "001". 3.For dual compressor system, if only system 2 has this failure and the dip-switch setting is OK, then please try with a new outdoor power PCB.
	00 P3	Operation panel communication protection	If an external control unit is connected and has communication, unit keeps on working; if no external control unit is connected, unit stops.	Communication data lost too much. Check whether communication cable is correctly connected; check whether communication cable is longer than 30M; whether there has a source of the disturbance nearby the unit. Replace the operation panel or indoor PCB if necessary. Unit recovers when communication recovers.
	00 P4	Master unit communication protection	Unit stops only when external master controller is connected and activated, otherwise unit keeps on working with the current setting.	This failure happens when an external master unit is used to control the heat pump unit via Modbus. Communication data lost too much. Check whether communication cable is correctly connected; check whether communication cable is longer than 30M; whether there has a source of the disturbance nearby the unit. Unit recovers when communication recovers.
	00 P5	System 2 indoor anti-freezing protection in cooling	Compressor of system 2 speed down or stop. If this failure doesn't recover automatically after 3 minutes, it must have happened over 3 times in a certain period of time. If so, it can only be recovered by repowering the unit.	1. Check whether set temperature for cooling is too low; whether system has too small water flow rate; check water system especially the filter. 2.Check whether system has not enough refrigerant inside by measuring the evaporating pressure. 3.Check whether ambient temperature is lower than 15°C.



### 3. Usage

Type	Code	Failure	Unit working statue	Possible Reasons And Solutions
Failure	00 P6	System 1 indoor anti-freezing protection in cooling	Compressor of system 1 speed stops. If this failure doesn't recover automatically after 3 minutes, it must have happened over 3 times in a certain period of time. If so, it can only be recovered by repowering the unit.	1. Check whether set temperature for cooling is too low; whether system has too small water flow rate; check water system especially the filter.2.Check whether system has not enough refrigerant inside by measuring the evaporating pressure. 3.Check whether ambient temperature is lower than 15°C.
	00 P7	Too small water flow rate protection	Unit will restart after 3 minutes	System water flow rate is less than minimum allowable flow rate. If the same protection happens over 3 times in certain period of time, unit will not restart and show "too small water flow rate failure". Check the water system, especially the filter; check the working statue of water pump. Check whether flow switch is broken so it is blocked in "OFF" mode.
	00 P8	Water outlet Temp. too low protection in cooling	Compressor stops	Compressor stops if water outlet is lower than 5°C in cooling mode. Check whether temperature sensor Tc is OK and well connected; whether set water temperature too low; whether system flow rate too small.
	00 P9	Water outlet Temp. too high protection in heating/hot water	Compressor stops	Compressor stops if water outlet is higher than 57°C in heating or hot water mode. Check whether temperature sensor Tc and Tw is OK and well connected; whether set water temperature too high; whether system flow rate too small.
	00 Pa	System 2 Water outlet Temp. too low protection in defrosting	Compressor of system 2 quit defrosting and switch back to heating/DHW operation	When unit is working in defrosting, if water outlet temperature is too low, water may freezing up in plate heat exchanger and damage the plate heat exchanger. When this happens, unit quit defrosting and switch back to heating/DHW operation. It may cause quite thick ice on evaporator coil. Please set the set temperature for heating/DHW higher, or turn ON the back-up heating system so actual water temperature is high enough for defrosting operation. If water volume in the system is too small that cause the water temperature drops too much in defrosting operation, please add a buffer tank that matches the unit capacity to the system. Please check whether indoor coil temperature sensor and water outlet temperature sensor is mixed, so the reading of outlet water temperature drops dramatically during defrosting operation.

## 3. Usage

Type	Code	Failure	Unit working statue	Possible Reasons And Solutions
Failure	00 Pb	System 1 Water outlet Temp. too low protection in defrosting	Compressor of system 1 quit defrosting and switch back to heating/DHW operation	When unit is working in defrosting, if water outlet temperature is too low, water may freezing up in plate heat exchanger and damage the plate heat exchanger. When this happens, unit quit defrosting and switch back to heating/DHW operation. It may cause quite thick ice on evaporator coil. Please set the set temperature for heating/DHW higher, or turn ON the back-up heating system so actual water temperature is high enough for defrosting operation. If water volume in the system is too small that cause the water temperature drops too much in defrosting operation, please add a buffer tank that matches the unit capacity to the system. Please check whether indoor coil temperature sensor and water outlet temperature sensor is mixed, so the reading of outlet water temperature drops dramatically during defrosting operation.
	00 Pc	Water system anti-freezing protection stage 1	Circulation pump circulates for 1 minute in every 6 minutes	When unit is turned OFF, if ambient temperature and water temperature is low, water system has the risk of freezing up. Thus it is necessary to have the circulation pump starts to circulate the water in the system, for anti-freezing purpose.
	00 Pd	Water system anti-freezing protection stage 2	Compressor starts automatically.	When unit is turned OFF, if ambient temperature and water temperature is too low, unit will start to work automatically to heat the water up to a minimum safe level. This is a minimum protection for protecting to help preventing the water system from freezing up. Other solutions must be added according to local regulations to ensure the safety of water system.

### Failure for Wired Controller

Type	Code	Failure	Unit working statue	Possible Reasons And Solutions
Failure	03 P3	Wired communication protection	If a external control unit is connected have communication, unit keeps on working; if no external control unit is connected, unit stops.	Communication data lost too much. Check whether communication cable is correctly connected; check whether communication cable is longer than 30M; whether there has a source of the disturbance nearby the unit. Check whether the dip-switch DIP2-2 is set to ON, which system has a external master control unit and doesn't need a operation panel. If yes, set it back to OFF. Check and replace the indoor PCB if necessary. Unit recovers when communication recovers.

### 3. Usage

**Protection preserved for other models(Check below part if unit stops without any failure information in cooling or defrosting mode):**

Type	Code	Failure	Unit working statue	Possible Reasons And Solutions
Failure	LED light on outdoor PCB blinks 13 times	Water flow switch protection (preserved for monoblock unit that has water flow switch installed in outdoor unit only)	Compressor stops.	If there has no water flow switch installed in outdoor unit, please check whether "LOW" port on outdoor PCB is short-connected or not. If not, please use a jumper to short-connect this port.
	LED light on outdoor PCB blinks 24 times	Water flow switch failure (preserved for monoblock unit that has water flow switch installed in outdoor unit only)	Compressor stops.	If there has no water flow switch installed in outdoor unit, please check whether "LOW" port on outdoor PCB is short-connected or not. If not, please use a jumper to short-connect this port.

# 4. Maintenance

## 4.1 Attention

- 1) The user mustn't change the structure or wiring inside the unit.
- 2) The service and maintenance should be performed by qualified and well-trained technician. When the unit fails to run, please cut off power supply immediately.
- 3) The smart control system can automatically analyze various protection problems during daily use, and display the failure code on the controller. The unit may recover by itself. Under normal operation, the piping inside the unit don't need any maintenance.
- 4) In normal ambient conditions, the user only needs to clean the surface of the outdoor heat exchanger per month or quarter of a year.
- 5) If the unit runs in a dirty or oily environment, please clean the outdoor heat exchanger by professionals, using specified detergent, to ensure the performance and efficiency of the unit.
- 6) Please pay attention to the ambient environment, to check if the unit is installed firmly, or whether the air inlet and outlet of the outdoor unit is blocked.
- 7) Unless the water pump is damaged, no special service or maintenance should be taken to the water system inside the unit. It's recommended to clean water filter regularly or change it when it's very dirty or blocked.
- 8) If the unit will not be used in winter for a long time, please drain all the water inside the system, to prevent the water pipes from damage due to freezing.

## 4.2 Cleaning of water filter

The water filter should be cleaned according to the manual of water filter, to ensure the water flow of the water system. It is recommended that it be cleaned once in the first month, and then, once half a year.

## 4.3 Cleaning of plate heat exchanger

Thanks to the normally very high degree of turbulence in the heat exchanger, there is a self-cleaning effect in the channels. However, in some applications the fouling tendency can be very high, e.g. when using extremely hard water at high temperatures. In such cases it is always possible to clean the exchanger by circulating a cleaning liquid (CIP-Cleaning In Place). Use a tank with weak acid, 5% phosphoric acid or, if the exchanger is frequently cleaned, 5% oxalic acid. Pump the cleaning liquid through the exchanger. This work should be done by qualified person. For further information, please contact your supplier.

## 4. Maintenance

### 4.4 Condenser coil

The condenser coils do not require any special maintenance, except when they are clogged by paper or any other foreign objects. Cleaning is by washing with detergent and water at low pressure, and then rinsing with clean water:

- 1) Before cleaning, make sure the unit is off.
- 2) Inner of the unit must be cleaned by qualified person.
- 3) Do not use gasoline, benzene, detergent etc. to clean the unit. And do not spray with insecticide. Otherwise the unit may be damaged. The cleanser special made for air conditioner cleaning is recommended.
- 4) Spray air conditioner cleanser into the coils. Let the cleaner sit for 5-8 minutes.
- 5) Then, spray the coil with clean water.
- 6) An old hairbrush works well for brushing surface dirt and lint off the fins. Brush in the same direction as the slots between the fins so the bristles go between the fins.
- 7) After cleaning, use a soft and dry cloth to clean the unit.

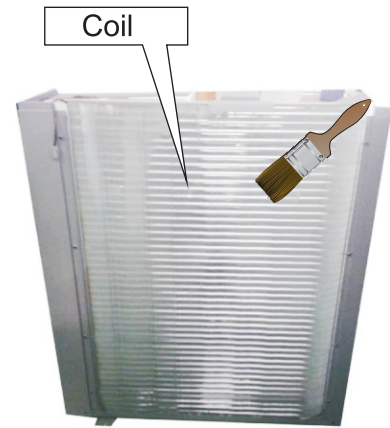

## 4. Maintenance

### 4.5 Service Of Monoblock Unit

#### 4.5.1 Service Of Water pump

- 1) Cut off the power supply, open the front panel and take off the electric box cover. Disconnect quick connector of water pump power cable, and pull out the signal cable connected to the indoor PCB.
- 2) Cut water supply to the unit, and drain out water in the indoor unit away. Use a wrench to loosen the connectors of water pump, and take the pump out from the unit.
- 3) Connect a new pump back to water system and electric system of the unit.

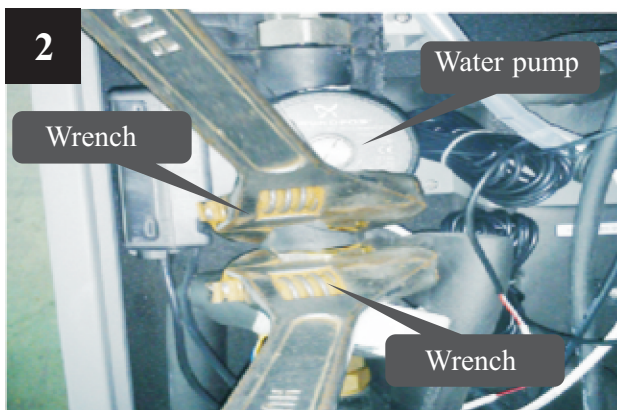
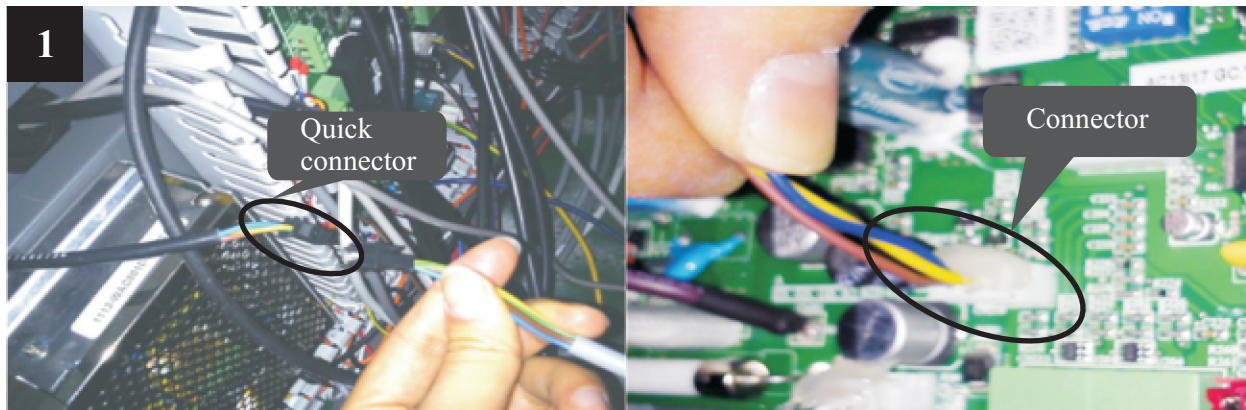

## 4. Maintenance

### 4.5.2 Maintenance of controller

- 1) Cut off the power supply, take off the top cover of the unit.
- 2) Take off the electric box cover.
- 3) Do necessary maintenance work to the controller of outdoor unit .

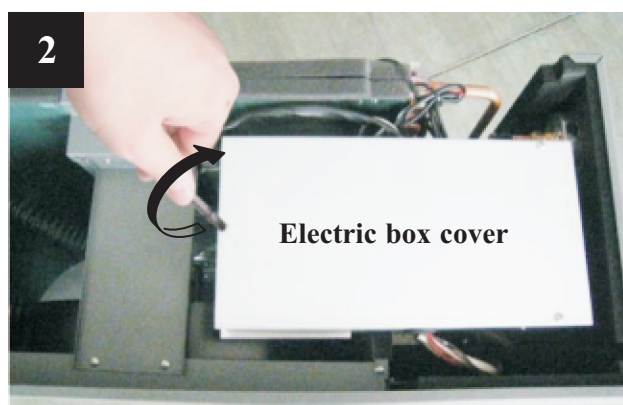

## 4. Maintenance

### 4.5.3 Replacement of fan motor

- 1) Cut off the power supply, take off screws of the front grill.
- 2) Use a wrench to loosen the nut for fan blade and take out the fan blade.
- 3) Take off the screws of fan motor.
- 4) Plug out power cable for fan motor from PCB.
- 5) Put the repaired or new fan motor back and connect all cables back.

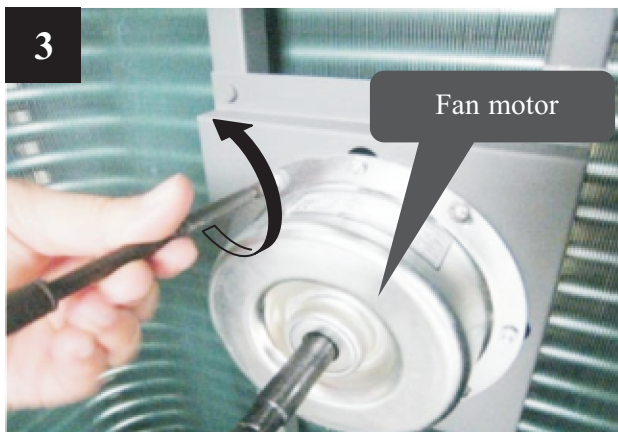
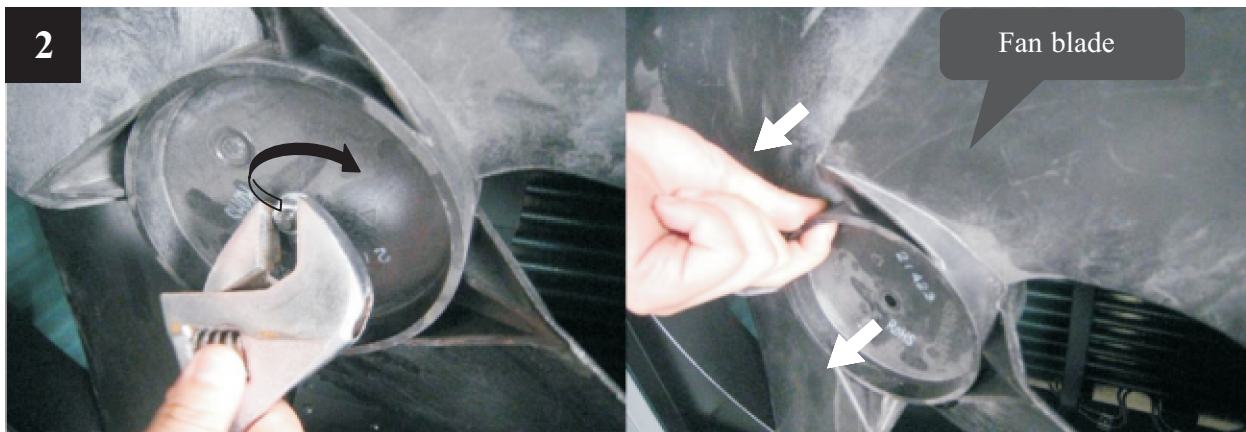



## 4. Maintenance

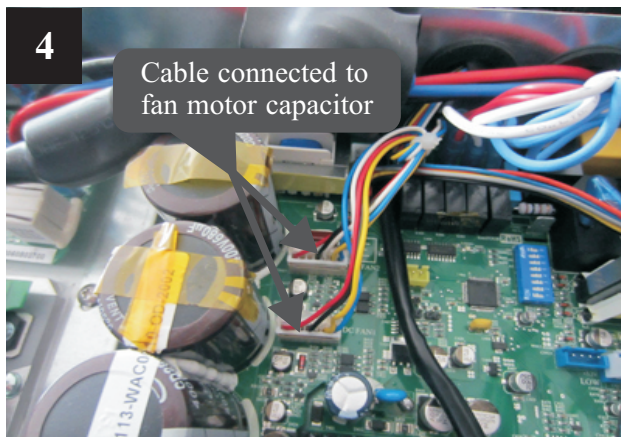

## 4. Maintenance

### 4.5.4 Replacement of bottom plate heater

- 1) Cut off the power supply, follows 4.7.2 to take out the fan blade.
- 2) Take off the fixture of bottom plate heater(see picture 1).
- 3) Disconnect the quick connector for bottom plate heater and take the heater out (see picture 2).
- 4) Put a new bottom plate heater back, and connect it to the quick connector(see picture 3).

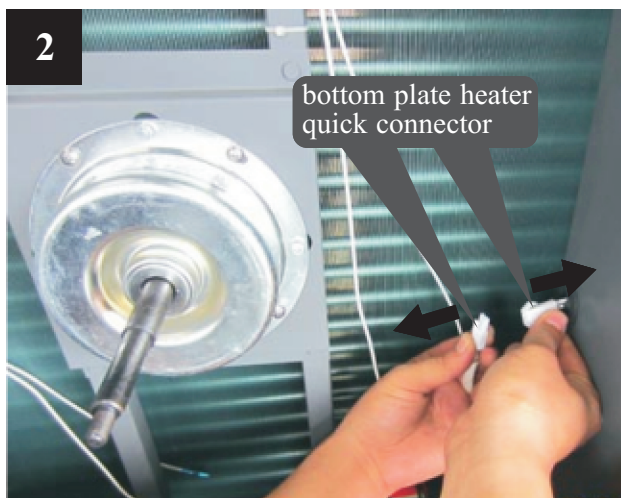
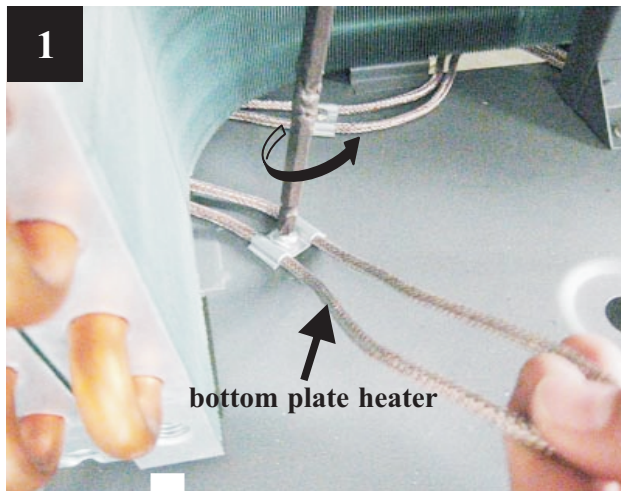

# 4. Maintenance

## 4.6 Trouble shooting

Failure	Cause	Solution
Unit can't start up	1. No power supply	1. Check the power supply
	2. Fuse is broken or circuit breaker is disconnected	2. Check if it's open circuit or if the unit is earthed. Then change a fuse and reset the breaker, check if the circuit is stable or the connection is well.
	3. Some kind of protection works	3. Check which protection is working, and clear the protection, then restart the unit.
	4. Wiring is loose	4. Check the wire connection and tighten the screws on the terminal
	5. compressor fails	5. Change a compressor
Fan fails to run	1. Fan motor wire loose	1. Check the wire connections.
	2. fan motor failure	2. Change fan motor.
Low heating performance	1. The coil fins are very dirty	1. Clean the evaporator coil
	2. Air inlet is blocked	2. Remove any object that blocks the air circulation of the unit.
	3. Insufficient of refrigerant	3. Inspect the unit for leakage and fix it if any. Discharge all refrigerant and charge the unit again with correct amount.
Too high noise from the water pump, or no water flow when the water pump is running	1. Lacking of water in water system	1. Check the water filling device. Fill the system with enough water.
	2. Air exists in water system	2. Purging the air out.
	3. Valves in water system are not completely opened	3. Check all the valves to ensure they are fully opened.
	4. Water filter is dirty or blocked	4. Clean the water filter
Too high compressor discharge pressure	1. Too much refrigerant	1. Discharge all refrigerant and charge the unit again with right amount.
	2. Air exists in refrigeration system	2. Discharge all refrigerant and charge the unit again with right amount.
	3. Inadequate water flow	3. Check the water flow of the system. Use a bigger pump to increase the water flow if necessary.
	4. Too high water temperature	4. Check the value of the water temperature sensor, to ensure it works properly.
Too low suction pressure	1. Drier filter is blocked	1. Change a new one
	2. Electronic expansion valve is not opened	2. Repair or change a new one
	3. Leakage of refrigerant	3. Inspect the unit for leakage and fix it if any. Discharge all refrigerant and charge the unit again with right amount.
Unit can not defrost properly	1. Coil temperature sensor failure	1. Check the position and value of the coil temperature sensor. Replace it if necessary.
	2. Air inlet/outlet is blocked	2. Remove any object that blocks the air circulation of the unit. Clean the evaporator coil occasionally.

## 4. Maintenance

---

The following phenomenon may not be problems of unit itself.  
Please contact with a professional maintenance staff for help.

Number	Failure	Solution
1	The unit is not running	When the unit restarts, the compressor will start 3 minutes later (self-protection of compressor), please check if the circuit breaker is disconnected, and if there is normal power supply for the wire controller.
2	Low capacity	Check if the air inlet or outlet is blocked in outdoor unit; check if the setting temperature is too high in cooling mode, or too low in heating mode.

# 5. Attached drawing

## 5.1 Outlines and dimensions

Monoblock — FRYO-9PI

Pipe Connection: 1"

Unit: mm

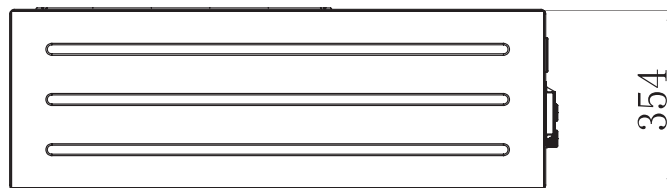
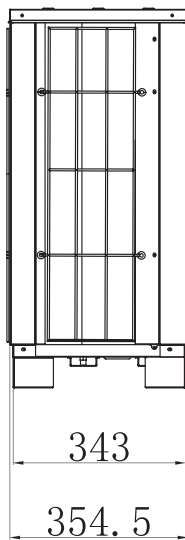
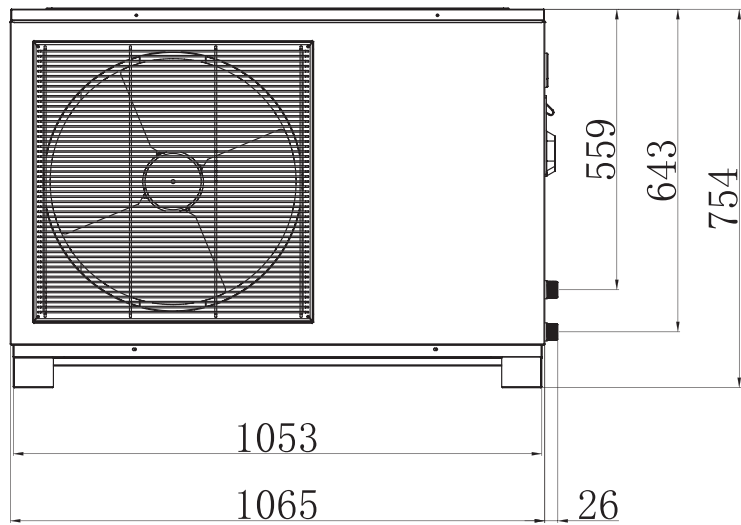
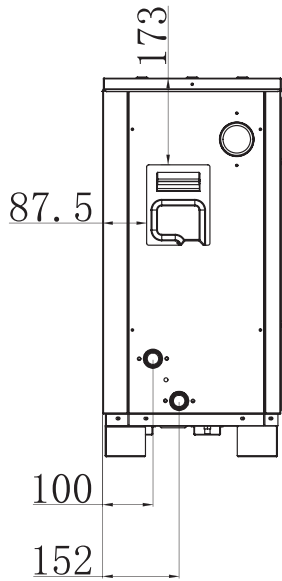

# 5. Attached drawing

Monoblock — FRYO-13PI

Unit: mm

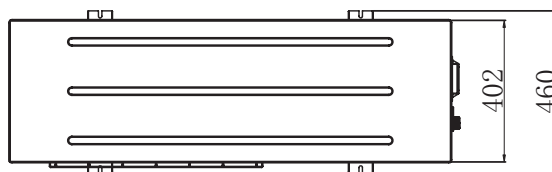
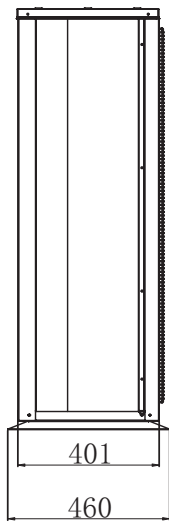
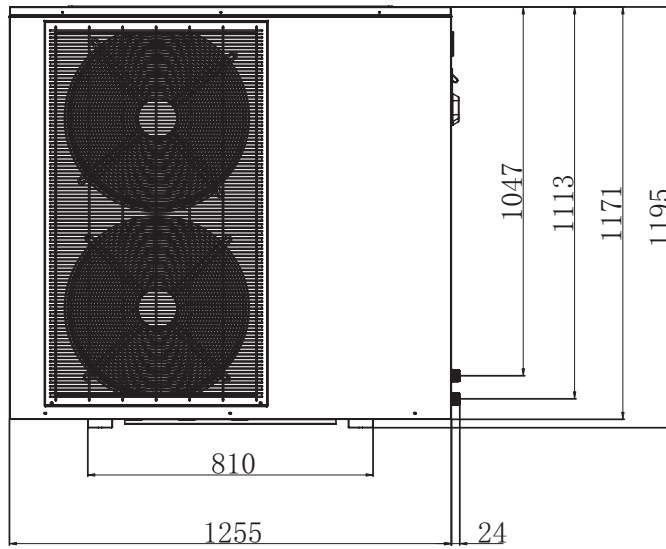
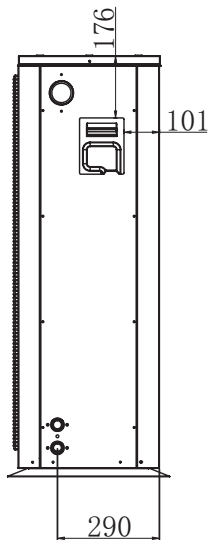

Pipe Connection: 1"

# 5. Attached drawing

## 5.2 Exploded View

Monoblock — FRYO-9PI

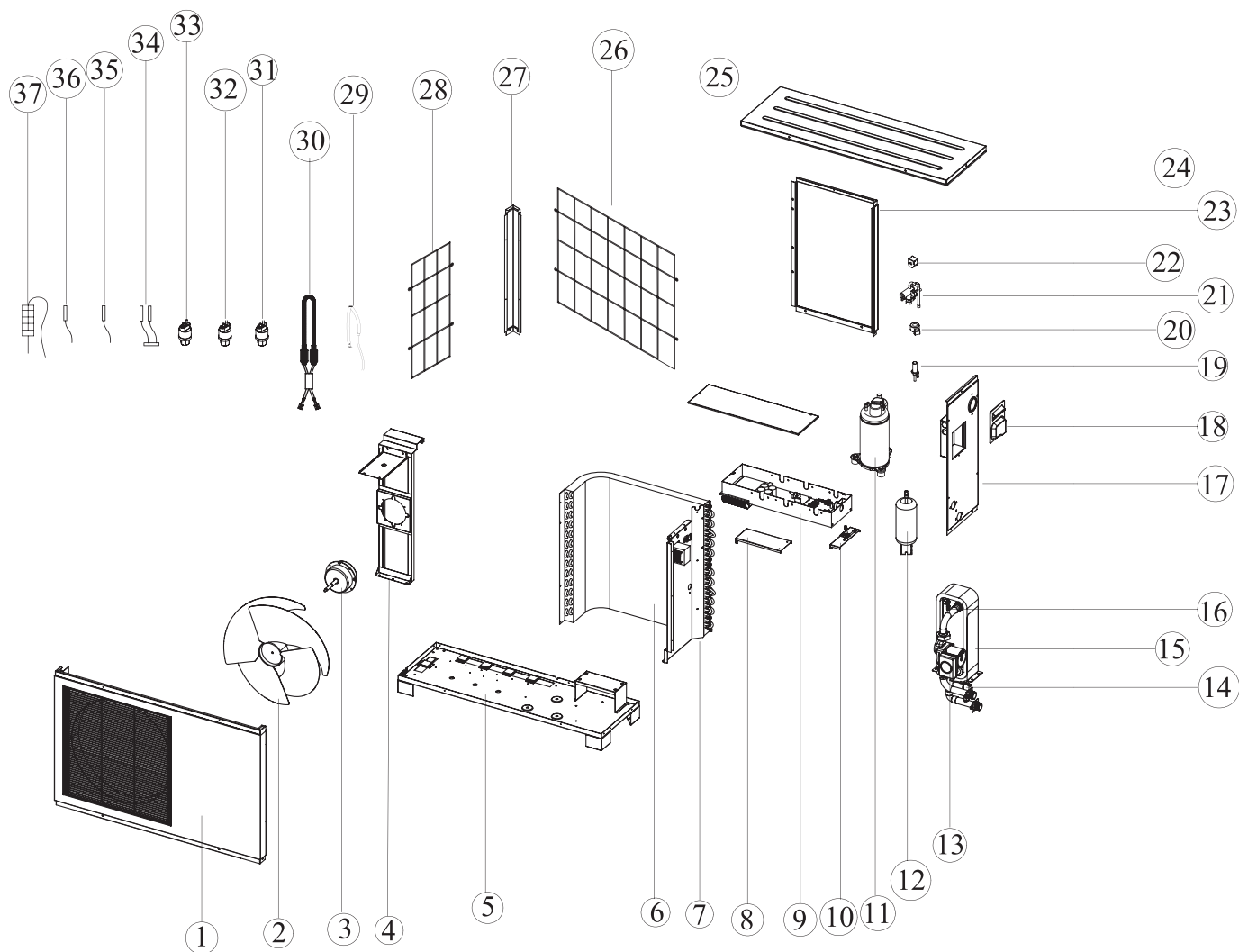

NO.	Name	NO.	Name	NO.	Name	NO.	Name
1	Front panel	11	Compressor	21	Four-way valve	31	High Pressure Switch
2	Fan	12	Separator	22	Four-way valve coil	32	High Pressure Sensor
3	DC Motor	13	Water Pump	23	Back panel	33	Low pressure Sensor
4	Motor Bracket	14	Water Flow Switch	24	Top Panel	34	Temperature Sensor
5	Bottom Plate	15	Plate Heat Exchanger	25	Electric Box cover	35	Compressor discharge temperature sensor
6	Condensor	16	Purge Valve	26	Back Grill	36	Temperature Sensor
7	Bulkhead	17	Side Panel	27	Column Support	37	Aluminum Foil Electric heater
8	Fixture	18	Big handle	28	Side Grill		
9	Electric Box	19	Electronic Expansion valve	29	Compressor heater		
10	Service Panel	20	Electronic Expansion valve coil	30	Condensor heater		

# 5. Attached drawing

## Monoblock — FRYO-13PI

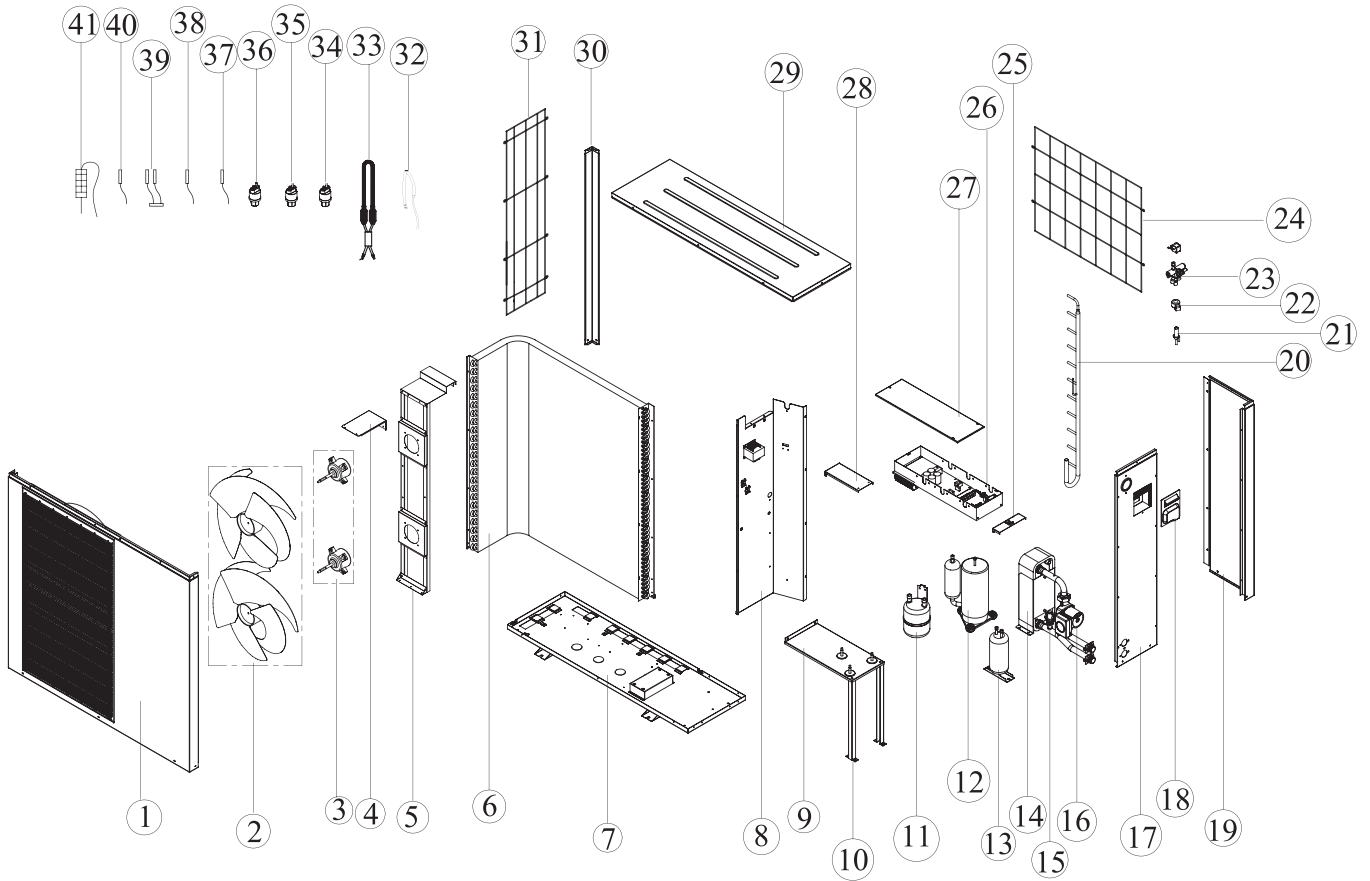

NO.	Name	NO.	Name	NO.	Name	NO.	Name
1	Front panel	11	Separator	21	Electronic Expansion valve	31	Side grill
2	Fan	12	Compressor	22	Electronic Expansion valve coil	32	Compressor heater
3	DC Motor	13	Expansion tank	23	Four-way valve	33	Condensor heater
4	Fixture	14	Plate Heat exchanger	24	Back Grill	34	High pressure switch
5	Motor Bracket	15	Water Flow Switch	25	Service valve fixture	35	High pressure sensor
6	Condensor	16	Water Pump	26	Electric box	36	Low pressure sensor
7	Bottom plate	17	Side Panel	27	Electric box cover	37-40	Temperature Sensor
8	Bulkhead	18	Big handle	28	Electric box support	41	Aluminum Foil Electric heater
9	Compressor Fixture plate	19	Back panel	29	Top Panel		
10	Compressor Support	20	Gas Distributor	30	Column Support		



# 5. Attached drawing

## 5.3 Wiring Diagram

Monoblock — FRYO-9PI  
FRYO-13PI

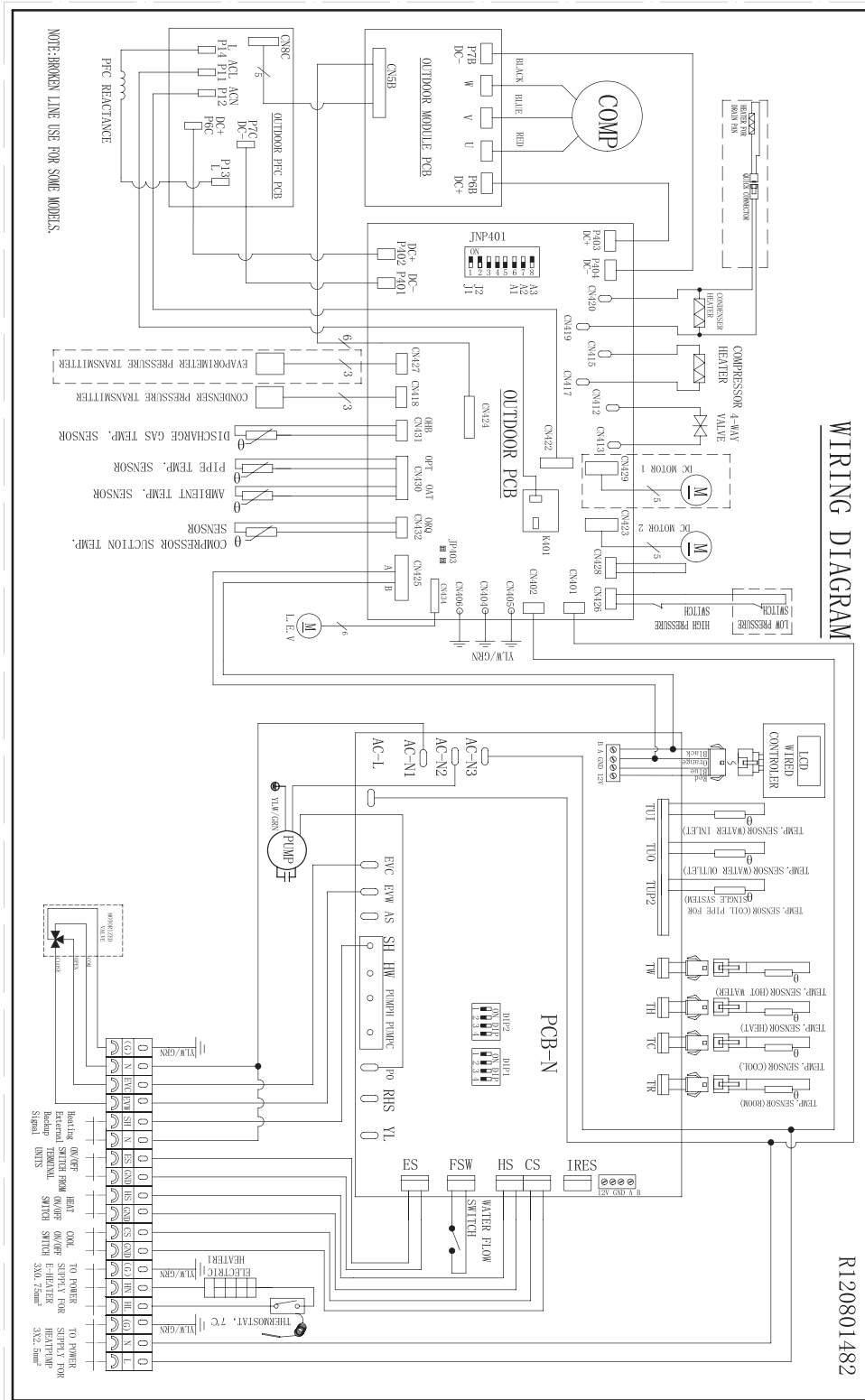

**TAKE CARE!**

This diagram is subject to change with improvement of the unit. Always refer to the diagram supplied with the product.



Thank you for choosing our quality product.  
Please read this manual carefully before use and  
follow the instructions to operate the unit in order  
to prevent damages on the device or injuries to staff.

Specifications are subject to change with product  
improvements without prior notice. Please refer to the  
specification sticker on the unit for upgraded specifications.

R120400580,V1.0  
**January, 2018**

62403786 - R01 01-01-2018\_IT-UK