

# Adveco Immersion Heater Kits

## 18–36 kW Electric Immersions for DHW

# Installation, Operation, and Maintenance Manual



# Warnings

This manual should be read and understood prior to installation or operation of any Adveco immersion heater. Failure to read this manual or follow its printed instructions may lead to personal injury, damage to the immersion heater and damage to the water heating installation. These instructions should be kept in a safe and accessible place near the water heating unit.

All immersion heaters should be stored in a safe place prior to installation to prevent damage to the appliance or heater components. Any unused or discarded components must be disposed of in accordance with the Waste Electrical and Electronic Equipment Regulations (WEEE) 2018.

In line with the requirements of Building Regulation G3, all immersion heaters must have a method of control and two levels of overheat protection. One can be the temperature and pressure relief valve, and the other must be a non-self-resetting mechanical overheat thermostat. The control can be done through a simple control thermostat or a BMS system, but it is recommended that the overheat is always done with an overheat thermostat.

For tanks with multiple heat sources or multiple immersion heaters, the control can be individual and a single overheat thermostat can be used to stop all heat sources.

It is recommended that the overheat trips a separate switching device than the control thermostat. For example, if the control thermostat switches the immersion heater via a contactor, then the overheat thermostat should shut off the immersion by tripping the breaker or another contactor. This protects against an unstoppable immersion heater in the event of a failed control contactor.

In order to protect the contactor from damage due to high frequency cycling it is recommended to place the control thermostat/sensor at least 300mm above the immersion heater element.

To prevent stacking caused by immersion heaters it is recommended to ensure good circulation of water throughout the tank at all times.

Immersion heaters are designed to operate ONLY when the heating elements are totally immersed in water and must not be switched on when the heating elements are exposed to air.

## Not Included:

Additional components required for the installation and operation of this device include:

- A 3 phase contactor switch
- Overcurrent protection (18 kW: 30 A/phase; 24 kW: 40 A/phase; 36 kW: 60 A/phase)
- An approved isolator

Copyright © 2020 Adveco Ltd. All rights reserved.

No part of this publication may be copied, reproduced, altered and/or published by any means without the prior written approval of Adveco Ltd.

Any brand names mentioned within this publication are registered trademarks of their respective owners.

Adveco Ltd. reserves the right to modify specifications in this manual at any time and without notification.

Adveco Ltd. accepts no liability for third party claims arising from unauthorised use and/or use other than as directed within this manual.



# Contents

	Page
Product Description	4
User Instructions	
1. Responsibilities of the User	5
2. Operating Instructions	6
3. User Maintenance Requirements	7
4. Troubleshooting	7
Technical Details	
1. EB0018 / EB0018A: 18 kW Immersion Heaters	8
2. EB0019 / EB0019A: 24 kW Immersion Heaters	9
3. EB0021 / EB0021A: 36 kW Immersion Heaters	10
Installation Instructions	
1. Responsibilities of the Installer / Designer	11
2. Requirements of the Installation	11
3. Location & Handling	12
4. Controls	13
5. Mechanical Connections	14
6. Electrical Connections	15
7. Commissioning Procedure	16
Maintenance Instructions	
1. Maintenance Requirements and Check Procedures	17
2. Operational Faults and Troubleshooting	18
3. Element Rod Replacement Procedure	19
Spares and Ancillary Items	20
Contact Details & Warranty Information	21

# Product Description

## Adveco High Capacity Electric Immersion Heater Kits

The Adveco EB0018(A), EB0019(A), and EB0021(A) comprise a range of electric immersion heater kits with heating outputs from 18 to 36 kW, and are designed to provide domestic hot water as part of a system with direct or indirect water heaters. Each element is suitable for horizontal mounting using an integrated flange connection plate directly into the clean-out opening of the cylinder.

In addition to serving as duty heaters in a direct water heating application, electric immersion elements are ideal for use as backup heat sources. This ensures a continuous supply of hot water even in the event of a primary heat source failure, virtually guaranteeing a hot water supply so long as there is power to the building.

All immersion heaters are sheathed in Nicalloy 825 and are supplied with a factory fitted stainless steel flange plus EPDM gasket sized to fit into the clean-out access of the water cylinders. A pocket-mounted dual control and overheat thermostat is included to be installed in the tank above the element for use with the primary heater.

For further details of each immersion heater range please consult pages 8–10



# User Instructions

## 1. Responsibilities of the User

Hot water systems pose a potential risk for building occupants regarding temperature and biological risks. It is the responsibility of the building controller to assess the risk to the occupants of scalding or Legionella and put in place suitable steps to protect the occupants.

The risk assessment must be carried out by someone suitably qualified. The following documents offer guidance and assistance on responsibilities:

ACOP L8, 2014  
 HSG274 Part 2  
 Health and Safety at Work Act  
 Workplace (Health, Safety and Welfare) Regulations  
 HTM 04 01 Part A and B  
 Building Regulation Part G  
 BS EN 806 All parts  
 CEN/TR 16355

And any other standards, laws, guidelines, or rules in force in the location of the installation, past or future, that are current at the time of installation. This installation manual complements these rules and must not be considered to override them in any way.

A guideline to the responsibilities contained within the above documents as relating to Adveco electric immersion heater kits can be summarised as follows:

1. The temperature of hot water in any cylinder should be kept between 60-65°C at all times. Any secondary return system should always return at a minimum temperature of 50°C. Water at the furthest outlets must reach 50°C (or 55°C in healthcare premises) within 60 seconds.
2. Any outlets at which water could exceed 55°C must be clearly marked by a warning sign. Thermostatic mixing valves should be considered, especially where users are considered at high risk. These should be serviced at least twice per year.
3. A risk assessment of the hot water installation should be carried out by someone qualified to assess risks and make recommendations, and should be reviewed regularly. The results of these assessments should be considered when determining maintenance regimes.
4. The installation must be commissioned by a qualified person before use. See page 16 for further commissioning information.

Following the commissioning of a system and in compliance with the procedures and advice contained within this manual, responsibility lies with the building controller to maintain a safe standard of operation and regular maintenance procedures as required by the risk assessment. This includes ensuring that the equipment is not operated at temperatures or pressures in excess of those stated on the vessel data plate, nor exposed to a full or partial vacuum, such as can be present during draw-off or drainage of the system while the cylinder cold feed or vent are closed or obstructed.

Failure to maintain a minimum of annual maintenance may void any and all warranties. Full maintenance procedures should only be carried out by a suitably qualified person. Basic maintenance regimes, as determined through risk assessment, should be carried out by the user as directed on page 7.

# User Instructions

## 2. Operating Instructions

In installations where the immersion heater is connected to a central control panel or a building management system (BMS), operation and control of the immersion heater will be governed by those systems.

The temperature set-point of the control thermostat should not lie outside of the 60-65°C range to ensure the installation meets requirements in regards to Legionella control and safety standards as defined by Building Regulation Part G3. This should have been set by the installer and should not need to be altered. The temperature set point of the immersion heater can be confirmed by checking the commissioning report.

The immersion heater will turn off once the water temperature surrounding the control thermostat sensor in the tank reaches its temperature setting. Should the control thermostat fail, the overheat thermostat will force a cut-out of the immersion heater when the water temperature in the vessel reaches the overheat set point. In the event of an overheat cut-out, all overheat thermostats will require manually resetting.



Direct temperature control of the immersion heater can be adjusted by locating the combined control and overheat thermostat. Featured on the front face of the thermostat housing is an adjustable temperature dial for the control thermostat with a range of 25-65°C. The housing also features a non-self-resetting over-temperature safety cut out, which can be accessed for manual reset by unscrewing and removing the small black cover.

Left: E0010 dual control and overheat thermostat supplied for use with high capacity immersion heaters. Located mounted on the side of the water cylinder, typically positioned above the level of the immersion heater

**Putting into use:** The immersion element must remain submerged at all times. Ensure that the tank is full prior to operation. Turn on the isolator and allow a heat up period of 1 hour per 300 litres of water capacity, before confirming that the tank has come up to temperature.

**Taking out of use:** Turn and lock off the isolator. If conditions present a risk of freezing, or if the system will be out of use for an extended period of time, the tank should be drawn down to prevent frost damage or stagnation.

**Returning to use:** Following a short out of use period of more than three days but less than a week, it should be sufficient to turn on the isolator and bring the water tank up to 60°C for at least one hour with the secondary pump running. Outlets should be flushed before hot water use if there is no secondary return. If the system has been out of use for an extended period, a risk assessment must be carried out which may include cleaning and disinfection of the tank in accordance with the site control of Legionella policy.

# User Instructions

## 3. User Maintenance Requirements

To ensure the continued reliability and longevity of the immersion heater installation, as well as the safety of users, regular maintenance should be carried out by the end user as described here

- Isolate the mains electrical connection to the immersion heater terminal.
- Examine the immersion heater flange connection to the tank for any evidence of leaks.
- Once per year confirm that the thermostats are operating correctly by turning off all other heat sources and turning on the immersion heater. Allow the system to heat for 1 hour per 300 litres system capacity, without hot water draw off, then confirm that the temperature at an outlet without a thermostatic mixing valve is between 55-70°C within 60 seconds.
- In the event of any sign of wear, damage or other faults, do not return power to the immersion heater and instead contact your service technician immediately.
- Any other maintenance tasks as defined in the risk assessment and ACOP L8, such as periodic flushing of showers and terminal outlets, plus temperature checks of taps with and without thermostatic mixing valves to assess the hot water system temperature and safety against scalding.

## 4. Troubleshooting

In the event of fault or failure of an immersion heater, notify the installer or your agreed service partner. All maintenance, replacement and repair inquiries should be handled by a qualified service technician. All warranty enquiries must be administered by Adveco Ltd.

# Technical Details

## 1. EB0018, EB0018A: 18 kW Immersion Heaters

The Adveco EB0018 and EB0018A are electric immersion heater kits each with a heating capacity of 18 kW.

Specifications	EB0018	EB0018A
Capacity	18 kW	18 kW
Supply	415 V / 3 phase / 50 Hz	415 V / 3 phase / 50 Hz
Wiring	L1, L2, L3, N, E	L1, L2, L3, N, E
Power (three phase)	26 A per phase	26 A per phase
Heat intensity	9.4 W/cm <sup>2</sup>	7.8 W/cm <sup>2</sup>
Immersed length	460 mm (18")	460 mm (18")
E0010 control range	25–65°C	25–65°C
E0010 overheat set point	80°C	80°C
Compatible flange size	182 mm	257 mm
Element rod mounting	Fixed	Replaceable
Kit Contents	1× E0025 Flanged Immersion Element 1× E0042.1 182 mm EPDM Gasket 1× E0010 Dual Thermostat 8× M0078 M12 Bolts 8× M0079 M12 Washers	1× E0025A Flanged Immersion Element 1× E0042 257 mm EPDM Gasket 1× E0010 Dual Thermostat 10× M0080 M10 Bolts 10× M0081 M10 Washers

EB0018 Terminal Layout

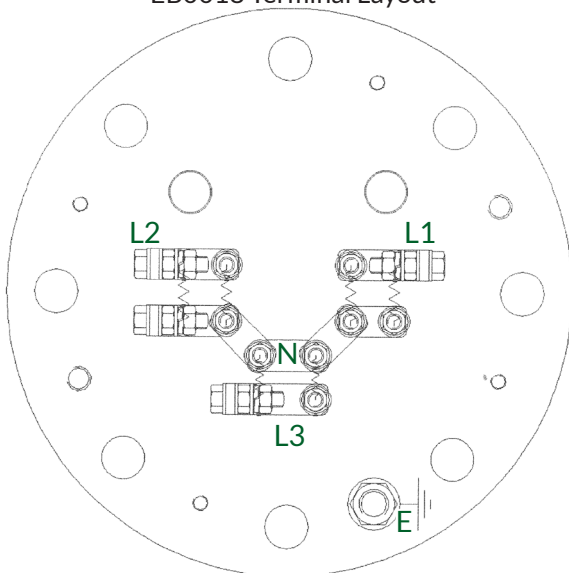

EB0018A Terminal Layout

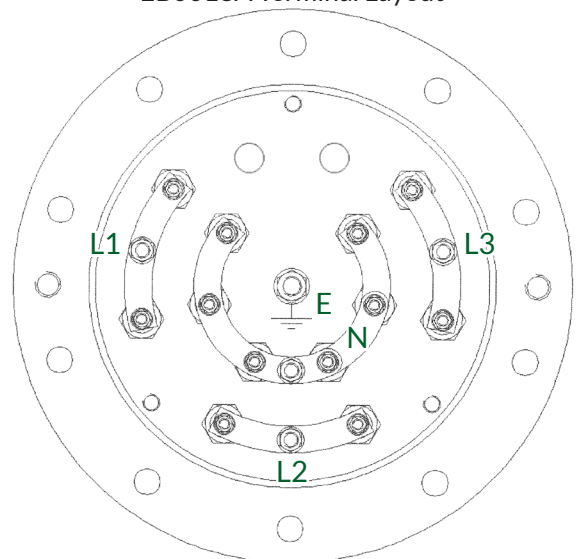

For further mechanical and electrical information, please see pages 14–15.



# Technical Details

## 2. EB0019, EB0019A: 24 kW Immersion Heaters

The Adveco EB0019 and EB0019A are electric immersion heater kits each with a heating capacity of 24 kW.

Specifications	EB0019	EB0019A
Capacity	24 kW	24 kW
Supply	415 V / 3 phase / 50 Hz	415 V / 3 phase / 50 Hz
Wiring	L1, L2, L3, N, E	L1, L2, L3, N, E
Power (three phase)	35 A per phase	35 A per phase
Heat intensity	9.1 W/cm <sup>2</sup>	9.2 W/cm <sup>2</sup>
Immersed length	510 mm (20")	510 mm (20")
E0010 control range	25–65°C	25–65°C
E0010 overheat set point	80°C	80°C
Compatible flange size	257 mm	182 mm
Element rod mounting	Replaceable	Fixed
Kit Contents	1× E0026A Flanged Immersion Element 1× E0042 257 mm EPDM Gasket 1× E0010 Dual Thermostat 10× M0080 M10 Bolts 10× M0081 M10 Washers	1× E0026 Flanged Immersion Element 1× E0042.1 182 mm EPDM Gasket 1× E0010 Dual Thermostat 8× M0078 M12 Bolts 8× M0079 M12 Washers

EB0019 Terminal Layout

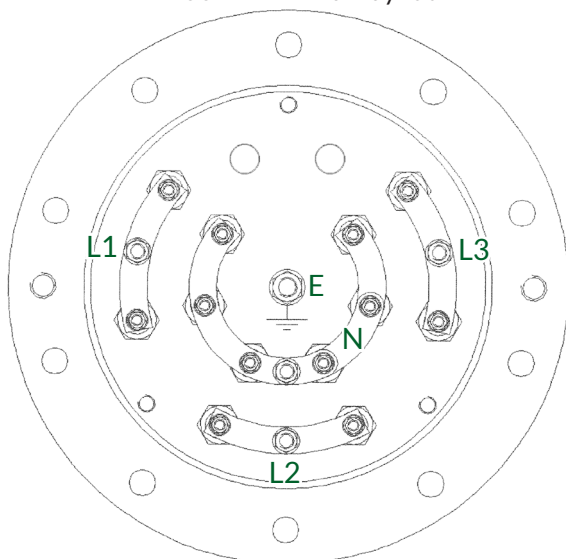

EB0019A Terminal Layout

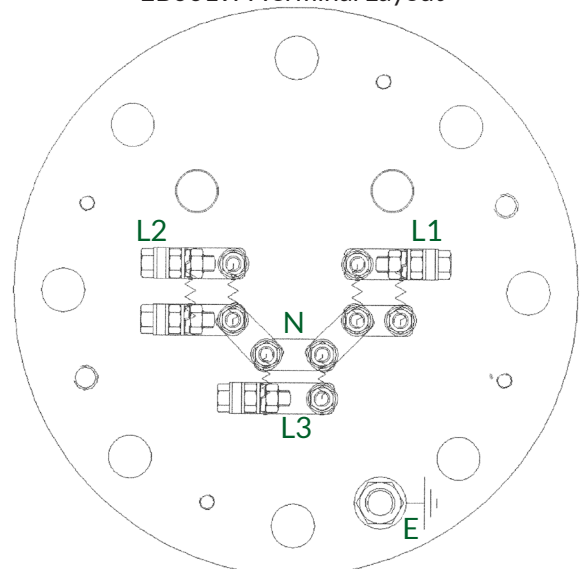

For further mechanical and electrical information, please see pages 14–15.

# Technical Details

## 3. EB0021, EB0021A: 36 kW Immersion Heaters

The Adveco EB0021 and EB0021A are electric immersion heater kits each with a heating capacity of 36 kW.

Specifications	EB0021	EB0021A
Capacity	36 kW	36 kW
Supply	415 V / 3 phase / 50 Hz	415 V / 3 phase / 50 Hz
Wiring	L1, L2, L3, N, E	L1, L2, L3, N, E
Power (three phase)	54 A per phase	54 A per phase
Heat intensity	9.1 W/cm <sup>2</sup>	9.1 W/cm <sup>2</sup>
Immersed length	510 mm (20")	510 mm (20")
E0010 control range	25–65°C	25–65°C
E0010 overheat set point	80°C	80°C
Compatible flange size	257 mm	182 mm
Element rod mounting	Glanded	Glanded
Kit Contents	1× E0028 Flanged Immersion Element 1× E0042 257 mm EPDM Gasket 1× E0010 Dual Thermostat 10× M0080 M10 Bolts 10× M0081 M10 Washers	1× E0028A Flanged Immersion Element 1× E0042.1 182 mm EPDM Gasket 1× E0010 Dual Thermostat 8× M0078 M12 Bolts 8× M0079 M12 Washers

EB0021, EB0021A Terminal Layout

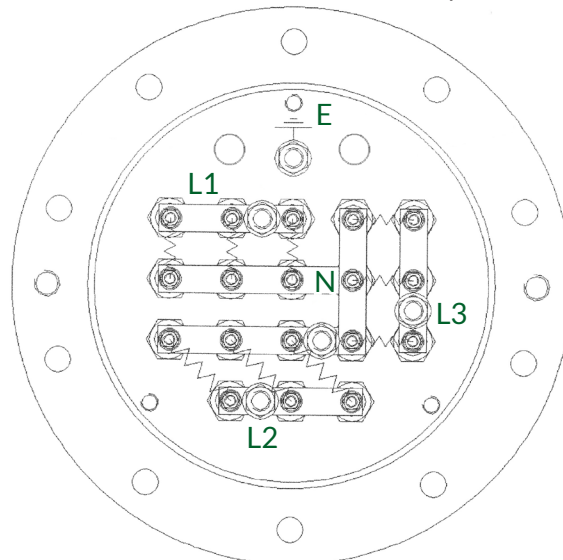

For further mechanical and electrical information, please see pages 14–15.



# Installation Instructions

## 1. Responsibilities of the Installer / Designer

All installation work for this immersion heater kit must be carried out by an individual with the relevant qualifications and experience to work with electrical systems and who is registered with an electrical regulatory body such as NICEIC, and should be compliant to:

- BS 7671:2018 IET Wiring Regulations 18th Edition
- BS EN 806 all parts
- BS EN 60335-2-74, IEC 60335-2-74
- Building Regulation Part G
- Building Standards (Scotland) Regulations
- Health and Safety and Work Act 1974
- Local Byelaws

And any complementing or superseding documentation.

Adveco Limited accept no responsibility for failure to comply with the above or with safe working practices.

## 2. Requirements of the Installation

Adveco high capacity electric immersion heater kits are suitable for installation into systems with pressures up to a maximum of 10 bar and are operable in temperatures up to 90°C.

Hot water systems pose a potential risk for building occupants with regards to temperature and biological hazards. It is the responsibility of the system designer and/or installer to consider the risk to building inhabitants/end users of scalding or Legionella and put into place suitable steps to protect the occupants. This includes eliminating system dead legs and ensuring that the hot water temperature at the furthest outlets reaches at least 50°C (55°C in healthcare premises) within 60 seconds. Guidance and information on these responsibilities can be found by referencing the following documents:

- Building Regulations Part G
- Health and Safety at Work Act 1974
- BS EN 806
- ACOP L8, 2014 (4th edition)
- HSG0274 (part 2)
- HTM 04 01 part A and B

It is essential that there is an in-depth handover process to the building controller/user so that the ongoing responsibilities of maintenance, risk assessment, and system control are fully understood. The system design and intended control methods for temperature and biological hazards within the DHW system and associated building should be explained to and understood by the building controller/user.

Note that the installation of any electric heating element requires the use of an earthed power supply.

# Installation Instructions

## 3. Location & Handling

A suitable clearance of at least 800mm should be present between an installed immersion heater flange and any adjacent unit or surface to facilitate inspection, maintenance, removal and replacement of the immersion. The location of the equipment should provide sufficient lighting for maintenance purposes and be in close proximity to a suitable electrical supply. Suitable drainage should be present so that any leak from the cylinder will not risk submerging the immersion terminal or its electric connections.

Immersion heaters should be handled by lifting carefully from the integrated flange plate, supporting the length of the element where necessary. The equipment should not be lifted by the heating element or terminal housing alone which may lead to irreparable damage to the immersion heater. Care should be taken when moving or lifting to minimise the risk of damage to the equipment and any connected cylinder.

In order to protect the contactor from damage due to high frequency cycling it is recommended to place the control thermostat/sensor at least 300mm above the immersion heater element.



# Installation Instructions

## 4. Controls

It is requirement of Building Regulation G3 that all immersion heaters must have a dedicated control method and two levels of overheat protection. One method of overheat protection can be the temperature and pressure relief valve on the cylinder. The second must be a non-self-resetting mechanical overheat thermostat.

For tanks with multiple heat sources or multiple immersion heaters, the control can be individual and a single overheat thermostat can be used to stop all heat sources.

It is recommended that the overheat trips a separate switching device than the control thermostat. For example, if the control thermostat switches the immersion heater via a contactor, then the overheat thermostat should shut off the immersion by tripping the breaker or another contactor. This protects against an unstoppable immersion heater in the event of a failed control contactor.



E0010

Each Advenco immersion heater kit is supplied with an E0010 dual control and overheat thermostat as standard. This component features an adjustable dial for the control thermostat with a range of 25–65°C and a non-self-resetting over-temperature safety cut out beneath a small black cover, factory set to 80°C.

In order to protect the contactor from damage due to high frequency cycling it is recommended to place the control thermostat/sensor at least 300mm above the immersion heater element. To prevent stacking caused by immersion heaters it is recommended to ensure good circulation of water throughout the tank at all times.

The immersion heaters can alternatively be controlled by a central control panel or building management system (BMS).

The temperature set-point of the control thermostat should not lie outside of the 60-65°C range to ensure the installation meets requirements in regards to Legionella control and safety standards as defined by Building Regulation Part G3.

The immersion heater will turn off once the water temperature surrounding the control thermostat sensor in the tank reaches its temperature setting. Should the control thermostat fail, the overheat thermostat will force a cut-out of the immersion heater when the water temperature in the vessel reaches the overheat set point. In the event of an overheat cut-out, all overheat thermostats will require manually resetting. For the E0010, this can be done by unscrewing the black dial on the front face of the product and pressing the button located beneath.

Ensure immersion heater circuits are fully isolated prior to opening the immersion heater terminal housings.

In the event that a water heater includes multiple immersion heaters, a single isolator must be used to isolate all immersion heater circuits. If two separate supplies are used, a traffolyte label must be permanently fixed to the housing access door to inform maintenance personnel that there are multiple points of isolation.

# Installation Instructions

## 5. Mechanical Connections

The immersion heater is provided with an EPDM gasket and flange designed to fit directly into the clean-out access of a compatible vessel. The immersion heater can be removed for maintenance, cleaning, repair or replacement. Sealing compounds should not be applied around the flange, as upon setting they may harden and prevent removal of the heater assembly.

To secure the immersion heater into the vessel, insert it into the clean-out access and begin by hand tightening the bolts labelled 1 & 2 on the terminal diagram below. The ring gasket can then be positioned correctly by resting it upon these two bolts, keeping it in place while the remaining bolts can be hand tightened.

Once all bolts are loosely screwed in and the immersion heater is positioned correctly, securely tighten all the bolts in a diametrically-opposed fashion to ensure an even stress loading across the immersion heater.

After installation the system should be filled according to its standard procedure and the cylinder checked to ensure no leaks are present around the immersion heater flange or thermostat pocket.

In the event that the system is flushed prior to commissioning, the flushing solution should be checked to ensure it will not damage the immersion heater.

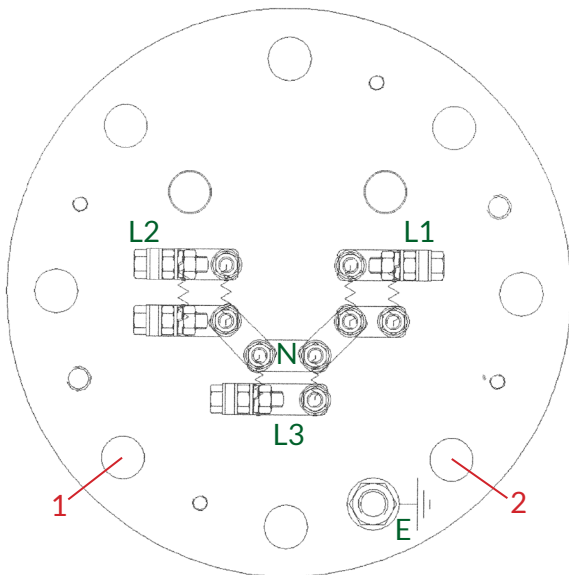

Left: EB0018, EB0019A Terminal Layout

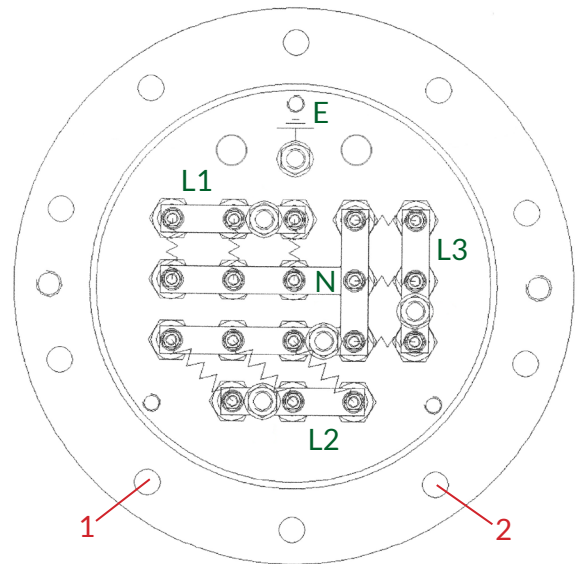

Above: EB0021, EB0021A Terminal Layout

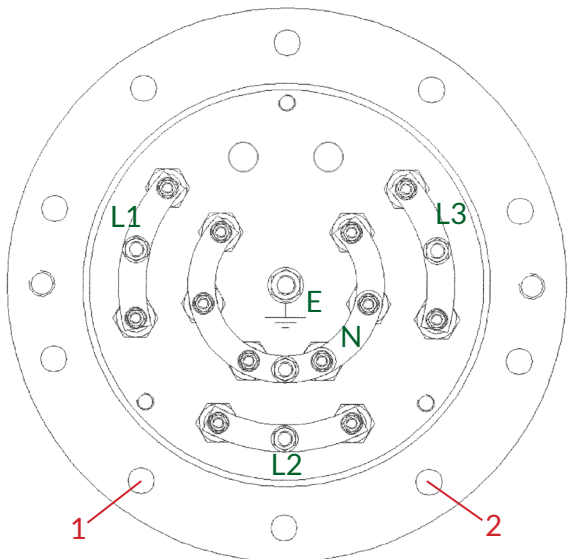

Left: EB0018A, EB0019 Terminal Layout



# Installation Instructions

## 6. Electrical Connections

All electrical wiring must be carried out by a qualified person and comply with the current IET Wiring Regulations to BS 7671:2018.

It is recommended that the electrical insulation for each circuit within the immersion heater is tested prior to installation. The minimum insulation reading between live and earth connections should be above 1MΩ. In the event that it is below 1MΩ, see the troubleshooting steps given on page 18.

Consult the relevant terminal diagram displayed on page 14 as a reference when making electrical connections. These immersion heater circuits are arranged for three phase electrical supplies. It is recommended that all wires are labelled with the phase and circuit number. Cable ring terminals or ferrules, depending on which is appropriate, should be used on terminal connections.

The immersion heater should be connected with fixed wiring and all cables and components should be correctly sized for the amperage.

An element to thermostat direct link wire should not be used. All terminal connections must use crimp ring connections.

It is recommended that the base of the terminal should be held securely (using pliers or another appropriate tool) when tightening or loosening, to ensure that the connection will not shear off if over-tightened.

An all pole isolator with a separation of at least 3mm must be used. Both circuits and all control wiring to thermostats must be supplied from one isolator to ensure a single point of isolation. If multiple isolators or electrical supplies are used, a traffolyte label must be permanently fixed to the housing access door informing maintenance personnel that there are multiple points of isolation.

It is recommended that control and overheat thermostats devices each trip a separate switching device. For example, if the control thermostat switches the immersion heater via a contactor, then the overheat thermostat should shut off the immersion by tripping the

breaker or another contactor. This protects against an unstoppable immersion heater in the event of a failed control contactor.

Note that each immersion heater terminal contains two thermostat pockets pre-supplied with control and overheat thermostats, but due to their proximity to a high capacity heating element these stats should remain disconnected and pockets unused to avoid the likelihood of nuisance tripping. Instead, the immersion heaters should be controlled by the E0010 dual control and overheat stat supplied with the kit, mounted separately on the cylinder above the level of the element.

**This appliance must be earthed.** An internal earth connection is contained within the terminal box. Note that fuses, contactors, isolators and on/off switches must be supplied separately.

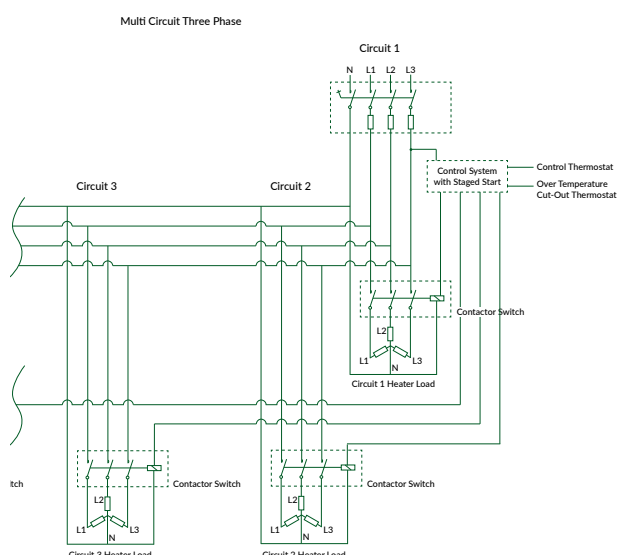

# Installation Instructions

## 7. Commissioning Procedure

Adveco electric immersion heaters require commissioning following installation and prior to use by the end user. This should be carried out by a qualified installer and responsibility is held by them to ensure that the system is safe for use.

Commissioning should include the following checks:

1. Ensure the integrity of all connections, including between the element, flange and water heater.
2. Ensure that all electrical connections are tight and that there is a gap of at least 5mm between any bare terminals.
3. Ensure that the control temperature setting  $T_{SET}$  of the E0010 combined thermostat is within the range of 60-65°C.
4. Open the mains water isolation valve and allow the system to fill with water.
5. Examine connections for evidence of leaks.
6. Measure the current to each element circuit with a clamp ammeter and ensure it is within range of the technical details given on pages 8–10 for your model of immersion heater.
7. Carry out a test of the E0010 combined thermostat temperature control function. Turn off all heat sources except the immersion heater, then allow a heat up period of one hour per 300 litres of system water capacity. Confirm that the temperature reaches, but does not exceed, the control thermostat setting.
8. Test the calibration of all overheat cut-out thermostats.
9. Hand over responsibility of the system to the building controller/user. Include a thorough explanation of the ongoing responsibilities of maintenance, risk assessment, and system control. Ensure that the building controller/user fully understands the system design as well as the temperature and biological hazard control methods used in the DHW system and associated building pipework.
10. Provide this document to the building controller/user alongside the commissioning report.





# Maintenance Instructions

## 1. Maintenance Requirements and Check Procedures

At minimum, the immersion heater should be serviced annually by a qualified engineer. An initial check should be carried out three months after installation, and the subsequent maintenance demand should be determined based on the level of scale build up. The unit must be fully isolated from the mains electricity supply prior to any inspection or maintenance work being carried out. The maintenance procedure should include at least the following checks:

1. Isolate the electrical power at the mains isolator and secure in the 'Off' position.
2. Inspect the mounted element and its physical connection for evidence of any damage or leaks.
3. Ensure that the terminal box is intact and its internal area is dry.
4. Ensure that all electrical connections are secure and show no signs of wear.
5. Check the phase to neutral or phase to phase resistance readings. When all elements are operating correctly, these readings should be around the same value.
6. If the resistance readings are not approximately equal, disconnect the incoming wiring and remove any busbars/wire links. Carry out a resistance check on each element to verify continuity.
7. Test the electrical insulation between the live and earth terminals and ensure the resistance is at least 1M $\Omega$ .
8. Test the amperage through each phase and confirm it is in line with the technical details given on pages 8–10 for the relevant immersion element.
9. In the event that element rods have failed, see the replacement procedure on page 19. Consider that as an element ages the likelihood of individual rods failing increases. It is only necessary to replace the immersion heater when it can no longer meet the DHW requirements of the building or if the phase loading becomes too imbalanced.
10. Drain the tank according to its standard procedure and remove the immersion heater. Check for visual wear on the gasket. Replacement of the gasket should be considered.
11. Examine the heater elements and thermostat pockets for visual signs of wear or build-up of scale deposits. Descale if necessary.
12. Inspect the tank flange and ensure that the interior of the tank does not contain scale deposits. Clean out any scale that is found.
13. Re-insert the heater assembly, secure and re-fill the tank according to the standard procedure.
14. Examine the flange connection and ensure no leaks are present.
15. Carry out a test of the E0010 combined thermostat temperature control function. Turn off all heat sources except the immersion heater, then allow a heat up period of one hour per 300 litres of system water capacity. Confirm that the temperature reaches, but does not exceed, the control thermostat setting.

# Maintenance Instructions

## 2. Operational Faults and Troubleshooting

Warning: Ensure that electrical supply is isolated and secured in an Off position prior to opening the terminal enclosure.

### 1. Heater is not operating correctly:

- Confirm that the control thermostat set point is correct. To avoid nuisance tripping, the over-temperature thermostat should be set at least 15°C higher than the control thermostat.
- Check the overheat thermostat for a trip. If it has tripped, investigate and rectify the cause of the trip.  
For systems controlled using the E0010 combined thermostat: Manually reset the thermostat by unscrewing the black dial on the front face of the E0010 and press the button located beneath.  
For systems controlled by control panel or BMS, consult the relevant documentation or contact your service partner.
- Investigate the heater circuit breakers for a trip. If the circuit breakers have tripped, check the individual elements for a short circuit.
- Check the main electrical supply for power in all phases.
- Test the control thermostat for failure in the 'open' position. Check by setting the thermostat to a temperature above ambient and test to ensure that there is continuity between the two terminals.
- Check the wiring between the heater and within the control system to ensure there are no loose or overheated connections.
- Check for element continuity (resistance) to ensure no elements are open circuit.
- Check that the thermostats are correctly sited. Consider that thermostats located too close to the immersion heater elements may result in nuisance trips due to the high output capacity of large immersion heaters.
- If the circuit breakers are tripping on a constant basis, the rating on the circuit breakers should be checked. The circuit breakers should be rated 10% to 20% higher than the current being drawn. Refer to the immersion heater technical information on pages 8–10 for power draw information.
- If wiring or control components are overheating, they should be upgraded to a higher current rating.
- If the above instructions have been followed and the heat output is still below expectations, it may be necessary to confirm that the immersion heater is correctly sized for the application.

### 2. Low element insulation:

All elements are sealed prior to dispatch to prevent moisture ingress, however storage conditions after dispatch are not always ideal, particularly if long delays occur between purchase and commissioning. The operation of the immersion heater is unlikely to be affected by low insulation. To avoid problems with earth leakage monitoring devices, it is recommended that the follow procedures are carried out:

- The terminals on the end of the element can be dried to remove any moisture, e.g. with a hair dryer or similar device.
- When brought into operation, the element will naturally improve in insulation. If an earth leakage monitoring device such as an RCD is being used, this can be disconnected for 24 to 48 hours while the heater is switched on to allow the insulation readings to increase.
- To maintain the insulation during periods of low use it is advisable to switch the heater on in the vessel, while fully immersed, approximately once a month for 48 hours.



# Maintenance Instructions

## 3. Element Rod Replacement Procedure

In the event that an element rod fails within an immersion heater featuring replaceable rods, the following procedure can be followed to perform the replacement. For the correct replacement element rods, please contact Adveco.

1. Isolate the electrical power at the mains isolator and secure in the 'Off' position.
2. Drain the tank according to its standard procedure and remove the immersion heater.
3. Disconnect the element support banding from the element(s) to be replaced.
4. Remove line connections.
5. Remove busbar fixing nut, shakeproof washer, and plain washer.
6. Remove busbar and washer.
7. Remove gland nut.
8. Pull the old element free.
9. Replace with new element and joints.
10. Replace gland nut.
11. Replace plain washer(s) and busbar. It is vital that the busbars make a good connection and lie flat. Additional washers may be used to fill up gaps.
12. Replace plain washer, shakeproof washer, and nut.
13. Replace line connections.
14. Reinstall the immersion heater into the vessel, ensuring all connections are tight and sealed against leaks. Replacement of gasket should be considered.
15. Replace the enclosure and gland plate. Reconnect wires to the busbars and earth bonding bar.
16. Refer to the mechanical and electrical installation sections of this manual for further details on installation.

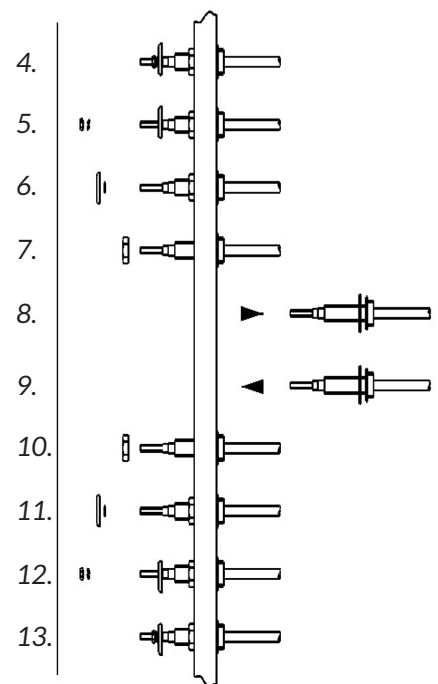

# Spares and Ancillary Items

## Spares

Item Description	Product Code
Replacement 18 kW Element for EB0018	E0025
Replacement 18 kW Element for EB0018A	E0025A
Replacement 24 kW Element for EB0019	E0026A
Replacement 24 kW Element for EB0019A	E0026
Replacement 36 kW Element for EB0021	E0028
Replacement 36 kW Element for EB0021A	E0028A
182mm EPDM Gasket for EB0018, EB0019A	E0042.1
257mm EPDM Gasket for EB0019, EB0018A, EB0021	E0042
Thermostat pockets for use with cylinder mounted thermostats: E0009.2: Single chrome-plated pocket E0009.5: Multi-stat stainless steel pocket	E0009.2 E0009.5

## Ancillaries

Item Description	Product Code
<b>Combined Control and Overheat Thermostat</b> Single terminal and pocket to be mounted on the side of a cylinder.	E0010
<b>Adveco Control Panels</b> Range of pre-wired central wiring and control panels compatible with electric immersion heaters. All panels include a system isolator, overload protection and auto-changeover support for multiple heat sources.	
EB0025: Designed for a gas fired primary heating system with electric immersion backup. Includes connections for Adveco HR001 heat recovery systems and an SMS dial-out to notify building managers or service partners of potential faults.	EB0025
EB0028: Designed for electric only systems with multiple immersion heaters. Includes connections for Adveco HR001 heat recovery systems and an SMS dial-out to notify building managers or service partners of potential faults.	EB0028
EB0030: Designed for a gas fired primary heating system with electric immersion backup. Includes connections for preheat appliances, Adveco HR001 heat recovery systems, and an SMS dial-out to notify building managers or service partners of potential faults.	EB0030
EB0041: Designed for a gas fired primary heating system with air source heat pumps and electric immersion backups. Includes connections for ASHP preheat and an SMS dial-out to notify building managers or service partners of potential faults.	EB0041



## Contact Details & Warranty Information

Adveco electric immersion heaters, this manual, and all information contained within, are supplied by Adveco Ltd.

Adveco Ltd.  
Unit 7&8 Armstrong Mall,  
Southwood Business Park,  
Farnborough,  
Hampshire,  
GU14 0NR

T: 01252 551 540  
enquiries@adveco.co  
www.adveco.co

The Adveco immersion heater kits described in this manual are supplied with a 12 months period, beginning from the date of supply, subject to the following conditions:

- The equipment is correctly and safely stored, installed, and used as instructed by this manual.
- The equipment is operated exclusively with potable water.
- The domestic hot water system is kept in a good condition and is suitably maintained, inclusive of appropriate maintenance of the immersion and connected cylinder.
- The equipment has not been altered, tampered with, and has not been subjected to damage from frost, vacuum, or external influence.

Exclusions to warranty conditions:

- Consumable parts (such as gaskets).
- Consequential damage arising from malfunction, failure, or leaks associated with the supplied equipment.
- Failure or damage of the immersion or domestic hot water system arising from the build up of excessive scale.
- Any parts and labour charges associated with maintenance, repair, or replacement of the immersion.

For further information and warranty claims, please contact Adveco Ltd.

Disposal of any part of an Adveco Immersion Heater Kit must be carried out in accordance with the Waste Electrical and Electronic Equipment Regulations (WEEE) 20183. The system must be decommissioned by a qualified engineer prior to any equipment disposal.

---

## Adveco also offer the following products and services:

- Bespoke system design
  - Maintenance and service packages
  - Buffer tanks
  - Indirect and direct hot water systems
  - Off site manufacturing of skids and plant rooms
  - Controls Systems
  - Packaged plate heat exchangers
  - Solar thermal systems
  - Gas fired heating systems
  - Combined heat & power cogeneration systems
- 

---

### Adveco Sales Department

T: 01252 551 540 Option 1  
E: Sales@adveco.co

### Adveco Technical Department

T: 01252 551 540 Option 4  
E: Technical@adveco.co

### Adveco Service & Commissioning Department

T: 01252 551 540 Option 6  
E: Service@adveco.co

---

### Adveco Spares Department

T: 01252 551 540 Option 3  
E: Spares@adveco.co

### Adveco Design Department

T: 01252 551 540 Option 5  
E: Technical@adveco.co



Adveco Ltd. Unit 7&8 Armstrong Mall, Southwood Business Park, Farnborough, Hampshire GU14 0NR  
Company Reg : 09493966 T: 01252 551 540 E: enquiries@adveco.co I: www.adveco.co

EXPERTLY ENGINEERED FOR YOU